

Data Aire Mini Ceiling Systems

1, 1.5, 2, and 2.5 ton capacities

R-407C



DAI
DATA AIRE INC.®

ISO 9001 Certified



Data Aire®

... the pioneer and builder of the
most complete line of
precision cooling equipment

Data Aire's first precision cooling system was developed by data processing engineers who sought optimum environmental conditions for early computers. It was clear that "people comfort" air conditioning systems were unable to meet the environmental requirements of computers and data processing equipment. Precision environmental control equipment with high sensible cooling ratios was a necessity. Problems with paper sticking, head crash, and static electricity were eliminated. Humidity fluctuations were controlled, saving possible electrical and mechanical failures and more importantly – Downtime. Data Aire's innovative response to the challenge of eliminating problems within the computer room environment was the start of wide use precision cooling.

As in the past, Data Aire is meeting today's challenge of not only the computer room but also the ever expanding telecommunications industry where precision cooling is vital to our everyday communications. Telecommunication equipment requires a controlled environment with clean and properly distributed air. As in the computer room, the environment must be precisely controlled – 24 hours a day, 365 days a year.

Data Aire produces solutions. We have offered environmental control solutions to meet specific needs in the smallest of places and in areas of thousands of square feet. We are prepared to assist you, your in-house engineering department, consulting engineer, or construction department in defining the proper solutions and bringing them to a predefined outcome.

Data Aire is committed to being the supplier of choice for environmental process cooling with flexibility, reliability, and expertise required to meet our customer's needs. To be successful, it is essential to be creative and use our resources to their fullest capabilities. The Data Aire goal is to benefit the employees, partners, and most of all – our customers with honesty and integrity.

Data Aire Delivers!

Mini Ceiling System

1, 1.5, 2, and 2.5 ton

Air and Water Cooled and Chilled Water

R-407C

TABLE OF CONTENTS

Design Features	6
Options	8
Configuration Drawings	
Package Systems	9
Split Systems	11
Performance Data Air and Water Cooled	13
Electrical Data	
Air Cooled.....	16
Water Cooled.....	19
Performance Data Chilled Water.....	20
Electrical Data Chilled Water.....	21
Weights.....	22

DATA AIRE, FOR ALL THE RIGHT REASONS!

PRECISION COOLING

Computers, batteries, electronic and telephone equipment have special comfort requirements. These spaces require air which is clean with precisely controlled temperature and humidity. Data Aire Mini Ceiling Systems™ are designed with this in mind. Building or “people comfort” systems simply are not designed to meet demands.

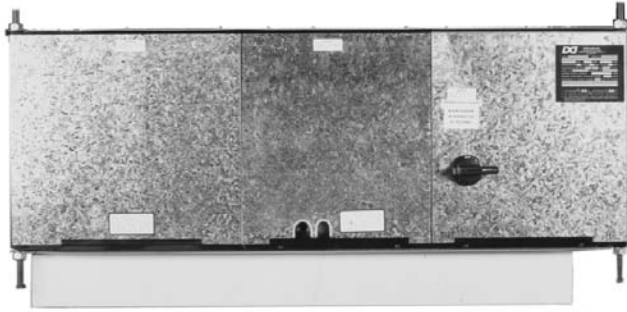

PERFORMANCE, LOW COST

Engineered and built by the people who introduced computer room air conditioning, the Mini Ceiling unit offers quality at a competitive price. Every Mini Ceiling System comes with Data Aire’s commitment to excellence which began with our first air conditioner and has been tested and proven for more than forty years.

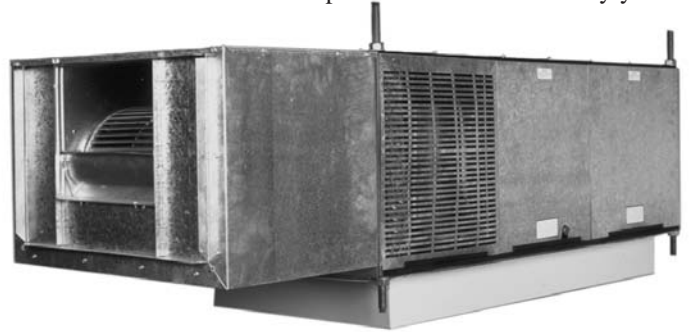

Units shown with optional side drain connections.

PEOPLE COMFORT

Although “thru-the-wall” systems may help cool your staff, they still fall short where precision cooling is needed. Data Aire’s Mini Ceiling Systems are the practical answer. It will keep your equipment on-line and will add to your personnel’s comfort as well.

DATA AIRE DELIVERS

Data Aire’s reputation for speedy delivery applies with special emphasis to the Mini Ceiling System. Units are shipped within a few days from receipt of order. Call your nearest Data Aire representative for details.

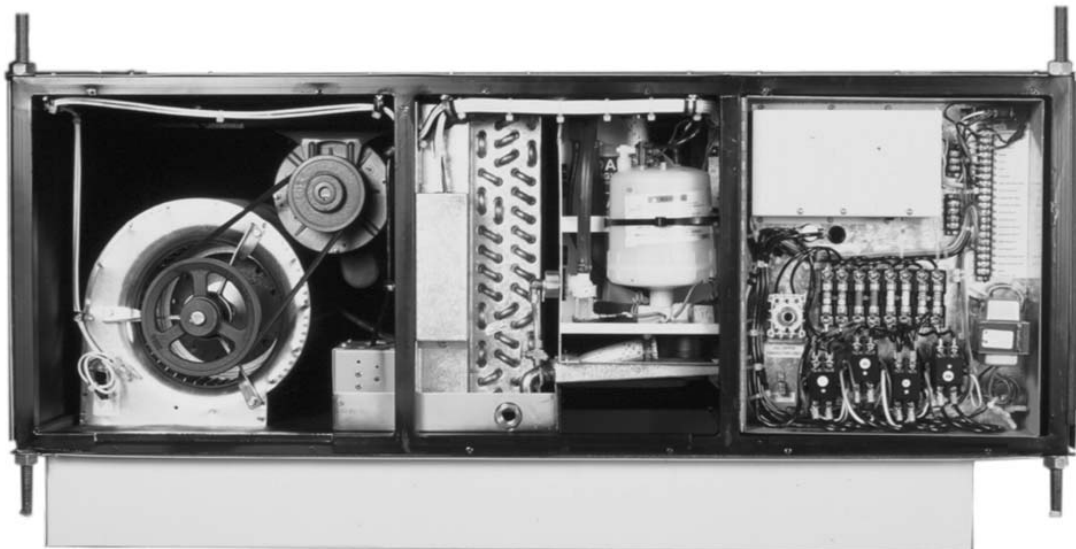

MINI CEILING SYSTEMS™

1, 1.5, 2, and 2.5 ton capacities

- Air Cooled
- Water Cooled
- Chilled Water

Data Aire's Mini Ceiling Series is the perfect environmental control system for small computer centers, electronic, telephone, and battery rooms, or wherever spot cooling may be necessary and space is a problem. While vertical supply/return air units are designed to fit in a 2 ft x 4 ft standard T-bar ceiling grid space, horizontal units hang in the ceiling space with duct work connected to supply and return connections. The system offers an unsurpassed combination of features and options along with a high standard of performance. Mini Ceiling Systems are available as air cooled, water cooled, or chilled water systems with a variety of return and supply air arrangements. Air cooled can be specified as packaged indoor units or split systems with either remote outdoor condensers or condensing units.

CONTROLS

Precise temperature regulation is provided by a built-in control system. All electrical components, including capacitors, contactors, relays, and control transformers are pre-wired and contained in an electrical box that is hinged and swings out for easy access and servicing. A factory installed micro-switch will disable the unit prior to condensate pan overflow should the drain line become plugged with debris. Each unit is shipped with a thermostat and subbase as standard. A red indicator light is unit mounted to indicate a condensate problem. Units with the optional *Mini Data Alarm Processor-II™* have a high condensate water level alarm standard.

CABINET

Units are designed with a supply and return air plenum that fits in a 2 ft x 4 ft opening of a standard dropped ceiling grid. The field installed supply and return air plenum is constructed of aluminum and finished with off-white textured paint. Both the supply and return air grilles are hinged for easy access when replacing filters. A 2 inch, MERV 8 efficient filters (based on ASHRAE Std. 52.2) is provided behind the return air grille. Mini Ceiling Systems are constructed with tubular steel frames for strength and service access. Removable panels of galvanized steel are lined with 1/2 inch thick, closed cell insulation for quiet and efficient operation.

EVAPORATOR SECTION

The evaporator coil contained in each unit is constructed with copper tubes and aluminum fins mounted in a stainless steel drain pan. The drain pan is made with a bottom drain connection and installed in a manner that provides a positive drain to prevent standing water in the condensate pan. The refrigeration circuit includes a scroll compressor with internal overload protection and crankcase heater. The circuit includes an expansion valve with an external equalizer, filter drier, sight-glass, and high and low pressure safety switches. The high and low pressure safety switches are connected

to the refrigerant system with a Schrader fitting that allows replacement without affecting the refrigerant charge, making recovery unnecessary.

The blower assembly is a draw-through type with a centrifugal, forward curved, double width, double inlet blower configuration engineered for quiet, reliable operation. The belt driven variable pitch drive provides adjustable air flow capability to match the requirements of the controlled space. The draw-through design insures even distribution across the coil, low internal cabinet losses, and static sealing of the filter section. The motor has internal overload protection and is mounted on an

SELF-CONTAINED UNITS

Air Cooled - The cabinet houses the evaporator section, evaporator blower assembly, filter section (located in air distribution plenum), and the condenser coil. The condenser coil is constructed of copper tubes and aluminum fins. The condenser blower section is field installed. The condenser fan is double inlet, double width, with direct drive type two-speed motor that is controlled with a temperature operated switch. The condenser blower motor electrical connection is through a factory wired plug.

Water Cooled - The cabinet houses the evaporator section, evaporator blower assembly, and filter section (located in air distribution plenum). In addition, a high efficiency plate fin condenser with head pressure activated 2-way water regulating valve is built into the refrigeration system and is contained in the evaporator section. The capillary tube connection from the water regulating valve to the refrigerant system is connected with a Schrader fitting that allows replacement without affecting the refrigerant charge, making recovery unnecessary.

Chilled Water - All components are housed within the cabinet. Chilled water units utilize an existing chilled water loop. Chilled water flow is controlled by a 2-way valve for accurate and economical temperature control and dehumidification. The maximum operating water pressure is 150 psi.

SPLIT SYSTEMS

Air cooled systems are available with an outdoor condensing unit or remote air cooled condenser.

Remote Outdoor Condensing Unit - The outdoor condensing unit contains the scroll compressor, sight-glass, filter drier, high and low pressure safety switches, and condenser coil. The high and low pressure safety switches are connected to the refrigerant system with a Schrader fitting that allows replacement without affecting the refrigerant charge, making recovery unnecessary. The condenser coil is constructed with copper tubes and aluminum fins. Air discharge is vertical. The condenser fan is variable speed for head pressure control down to -20° F. The capillary tube connection from the fan speed control to the refrigerant system is connected with a Schrader fitting that allows replacement without affecting the refrigerant charge, making recovery unnecessary. Field piping and wiring is required from the condensing unit to the indoor evaporator section.

Remote Outdoor Air Cooled Condenser - Condensers are industrial duty design with galvanized corrosion resistant housing, aluminum finned/copper tube coils, coated fan guard, energy efficient, thermally protected motor, and variable fan speed control with an integral factory wired and tested control panel. The capillary tube connection from the fan speed control to the refrigerant system is connected with a Schrader fitting that allows replacement without affecting the refrigerant charge, making recovery unnecessary. Air discharge is vertical. Field piping and wiring is required from the condenser to the indoor compressor/evaporator section.

Mini Ceiling Systems - OPTIONS

Unit Options

Remote Mounted Temperature and Humidity Sensors

Temperature and humidity sensors are provided in a wall mounted plastic case for remote sensing of temperature and humidity. Standard unit sensors are removed. Requires field wiring of (field provided) shielded cable. Remote temperature and humidity sensors option only available when used with the *Mini Data Alarm Processor-II*.

Steam Generator Humidifier

The steam generator humidifier eliminates air contamination caused by mineral deposits. The totally self-contained system includes a quick change, disposable cartridge, and automatic flush cycle. When steam generator humidifier option is selected, a *Mini Data Alarm Processor-II* is required.

Electric Reheat

Low-watt density finned tubular sheathed coils are constructed of stainless steel and provide ample capacity to maintain room

dry bulb conditions on a call for dehumidification. Low-watt density coils eliminate ionization associated with open wire electrical resistance heating. Electric reheat is available in 2, 4, or 5 kW capacities, shipped factory installed with high limit cutout.

Low Ambient Control Damper

A low ambient control damper is available for use with ducted outside condenser air. The low ambient control damper kit is field installed and consists of a 14" x 14" damper section and head pressure operator. The low ambient control damper allows unit to operate down to -30° F (-34.4° C). The capillary tube connection from the head pressure control to the refrigerant system is connected with a Schrader fitting that allows replacement without affecting the refrigerant charge, making recovery unnecessary.

Condensate Pumps

Condensate pumps can be provided for field mounting. Pump capacity is 60 GPH at 8 feet of head. Field installed condensate pumps require either separate 110 or 230 volt power source. The pump body should be placed exterior to the unit. Option 210, side mounting kit, is available for easy installation.

Horizontal, Front, or Side Supply Air

Units may be ordered with optional horizontal supply air configurations of front or either side. Optional supply air converts unit for ducted supply air connection.

Side Return Air

Units may be ordered with optional side return consisting of a factory modified flanged for ducting return air. Optional side return air converts unit for ducted return air connection. An additional option provides ceiling mounted return air filter grille, ceiling mounted return air filter box with hinged grille, and filter for duct connection. Filter included with this option is a 20" x 20" x 2" deep, MERV 8 efficient (based on ASHRAE Std. 52.2) pleated filter.

Extended Compressor Warranty

Extended compressor warranties are available from Data Aire. Contact your local representative for one that best suites your needs.

Site Monitoring

dar-4g2

Controls up to four Mini Ceiling units using a dry set of relay contracts. The DARA-4 provides unit rotation, backup capacity and the ability to interface with most BMS systems.

Optional Microprocessor Controller

Mini dap4 controller - The *Mini dap4* is an advanced controller with 50 MHz, 32 bit microprocessor and is comprised of three components, a wall mounted display module, a control module mounted inside the unit and a remote temperature and humidity sensor. The *Mini dap4* monitors the controlled environment's temperature, humidity, air flow, and cleanliness, but also provides alarm history and an automatic self-test of the microprocessor on system start-up. Multiple messages are displayed by automatically scrolling from each message to the next. All messages are presented in a clear vernacular format on the liquid crystal display (LCD). Multiple alarms are displayed sequentially in order of occurrence.

OPERATION - Holding down the "ESC" button for a minimum of five seconds activates the *Mini dap4*, push buttons allow menu selection for programming, operational information, diagnostics, and historical data. The two-level password feature prevents unauthorized access. Menu programmed information for basic system operation and alarm parameters is nonvolatile.

PROGRAMMABLE FUNCTIONS :

Temperature Setpoint	Temperature Deadband
System Start Delay	Low Temperature Alarm Limit
Humidity Deadband	Humidity Setpoint
High Humidity Alarm Limit	Low Humidity Alarm Limit
Define Password	Reset Equipment Runtimes
Audio Alarm Mode	Compressor Short Cycle Alarm
Humidity Anticipation	Compressors(s)
Calibrate Temperature Sensor	Temperature Scale
High Temperature Alarm Limit	Water Valve Voltage Range*
Firestat Temperature Alarm Limit	Manual Diagnosis
No water flow alarm action*	Remote Alarm contacts
Calibrate Discharge Air Sensor*	Person to contact on Alarm
Compressor Lead/Lag Sequence*	Dehumidification Mode
Power Problem or Restart Mode	Scheduled Normal Maintenance
Reheat mode	Calibrate Humidity
Humidifier	Compressor Assists to Energy Saver*
Network Protocol	Low Discharge Temperature Alarm Limit*
Calibrate Chilled Water Temperature Sensor*	

DISPLAYED CONDITIONS, DATA, and FUNCTIONS:

Temperature setpoints	Humidity setpoint
Current temperature	Current humidity
Cooling 1, 2 (as applicable)	Reheat
Humidification	Dehumidification

ALARMS - Alarm conditions are displayed and monitored on the microprocessor LCD along with an audible alarm. The alarm silence switch will quiet the audible alarm but the display will continue to indicate the alarm condition until it is corrected. The following alarms are displayed:

High temperature warning	High humidity warning
Low temperature warning	Low humidity warning
High pressure compressor	High condensate water level
Firestat tripped	No air flow
Compressor short cycle	Low voltage warning
Temperature sensor error	Power failure restart
Humidity sensor error	Local alarms
Maintenance required	Person to contact on alarm

HISTORICAL DATA:

High/low temperature last 24 hours	High/low humidity last 24 hours
Blower, compressor 1, compressor 2*, reheat, dehumidification, Energy Saver*, Equipment runtimes for:	
Humidifier, and chilled water *	Low temperature last 24 hour
Alarm history (last 100 alarms)	High humidity last 24 hours

* - Some of the programmable elections, displays or alarms may require additional components or sensors.

CONFIGURATION VERSATILITY

Data Aire Mini Ceiling Systems allow for a wide variety of supply and return options capable of satisfying the most demanding installation requirements.

PACKAGED SYSTEMS

Standard Configuration - is provided with one ducted attachment, the condenser air out from the end of the unit with flange. Condenser air intake is supplied from the side and top. Evaporator return air is supplied from below and the evaporator supply air is returned to the space below.

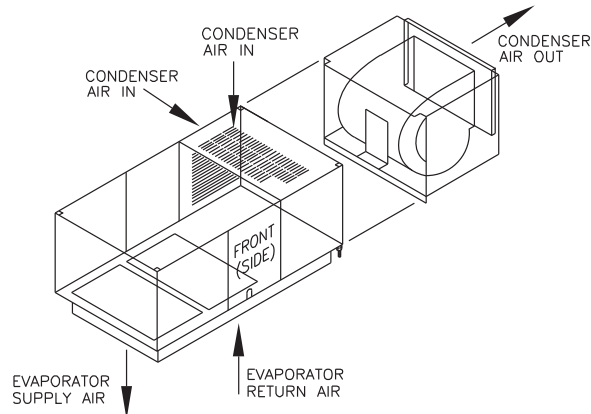

Mini Ceiling Systems with non-ducted condenser supply air

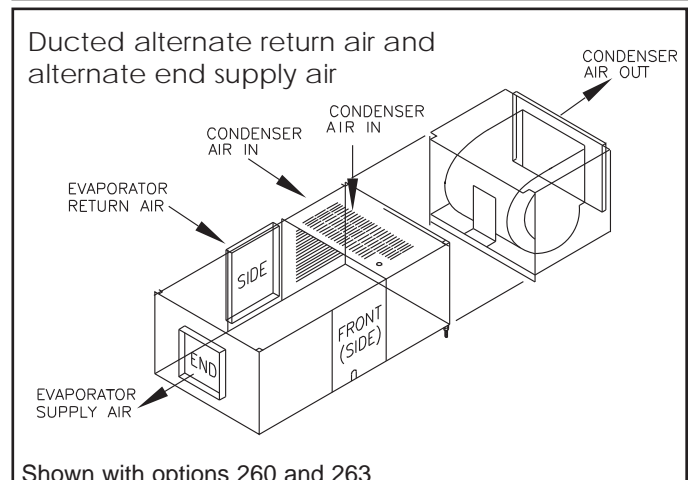
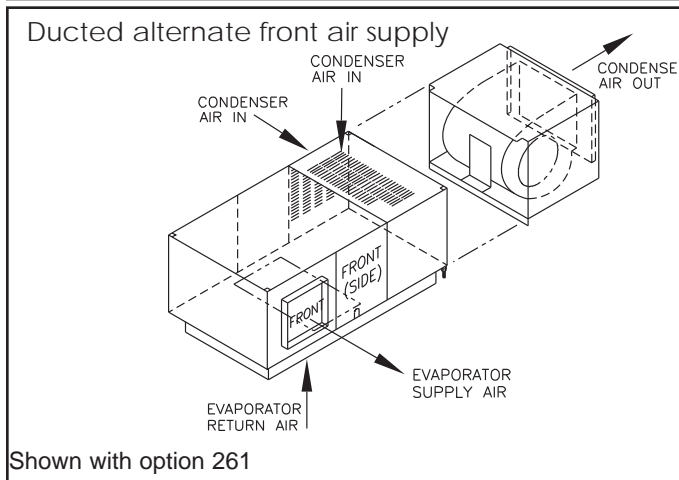
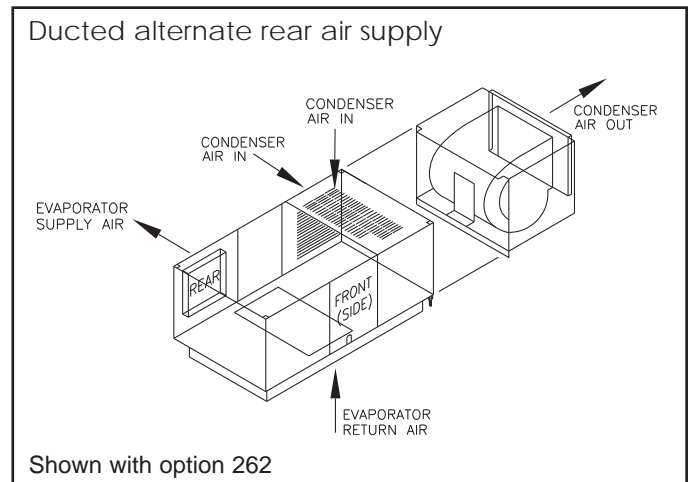
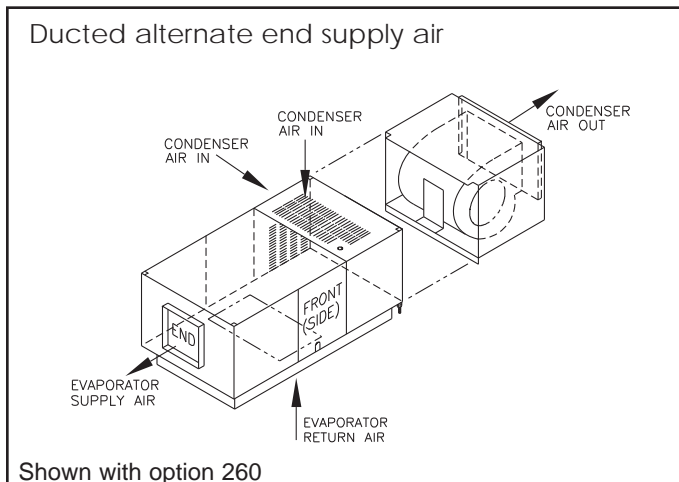

PACKAGED SYSTEMS

Mini Ceiling Systems with non-ducted condenser supply air

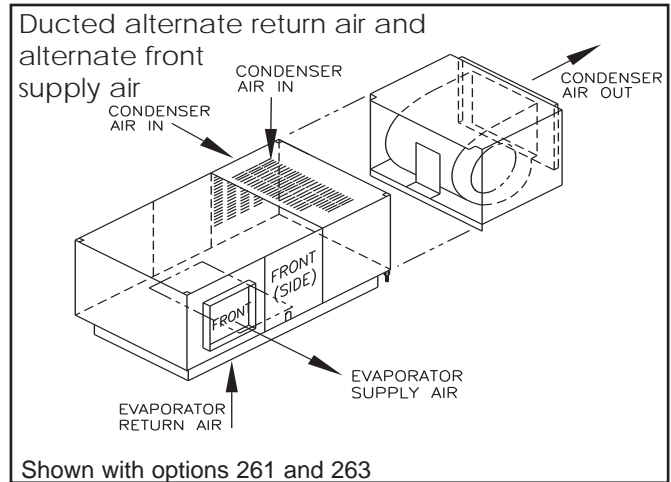
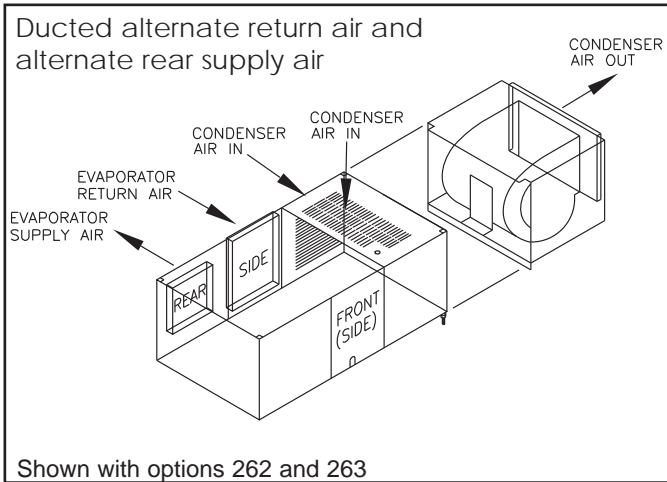

PACKAGED SYSTEMS

Mini Ceiling Systems with flange for condenser supply air

Standard Configuration - has flange for condenser air intake and condenser discharge air. Evaporator return and supply air are from the space below.

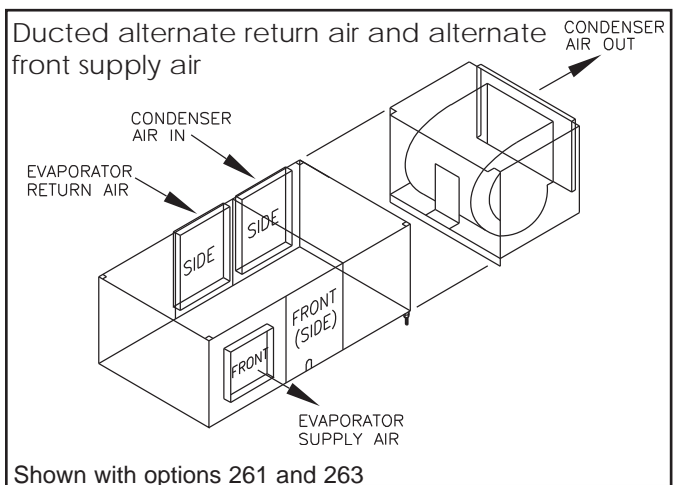
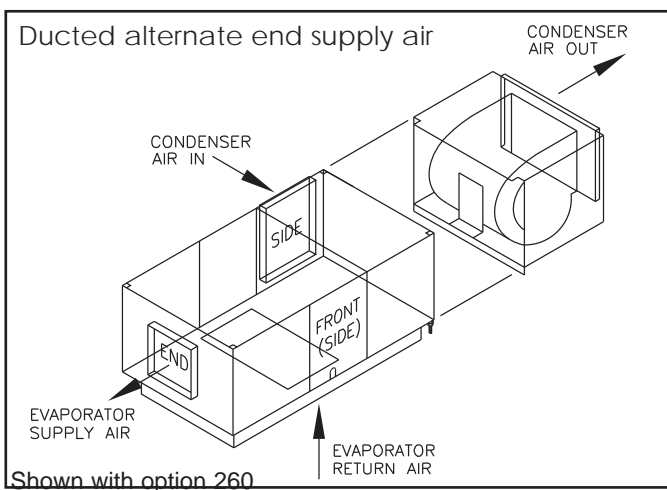
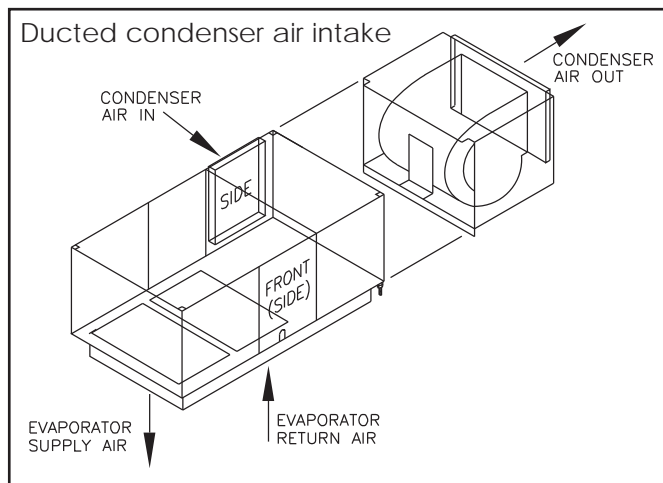

PACKAGED SYSTEMS - continued

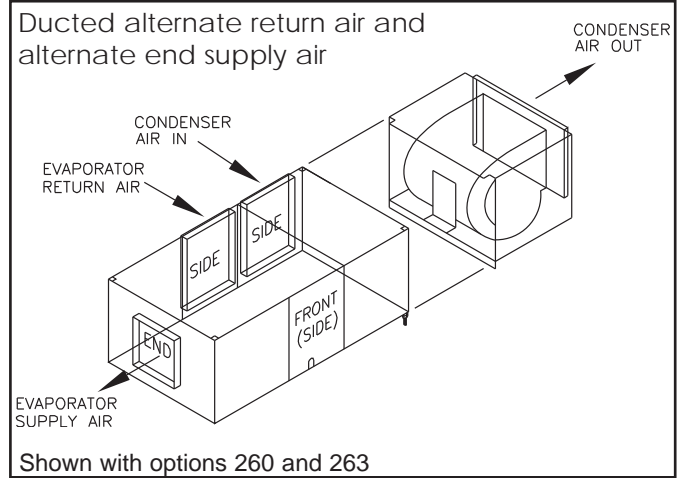
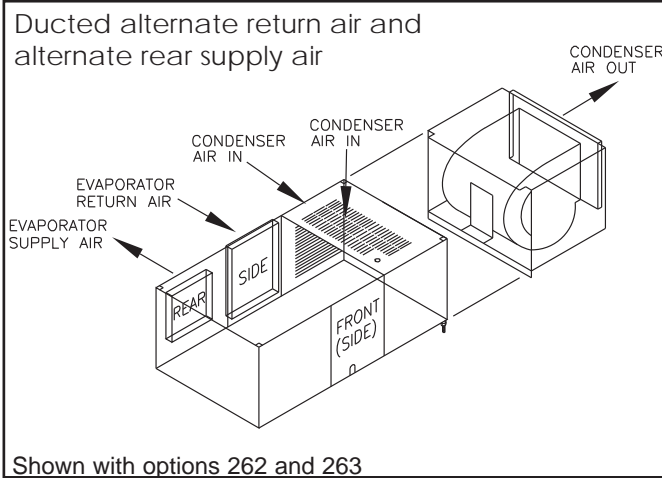

SPLIT SYSTEMS

Configuration of a split system is the same as the package system, except that you don't have to take into consideration the condenser supply and return air. Typical configuration is with the evaporator supply and return air from the space below, however all the following options are available to meet your requirements.

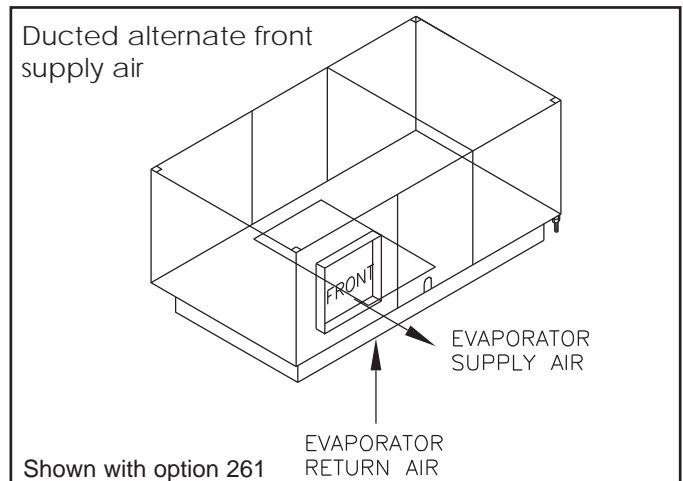
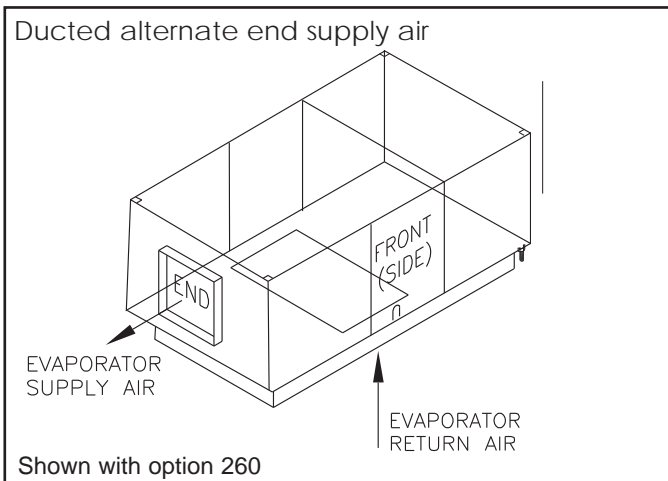
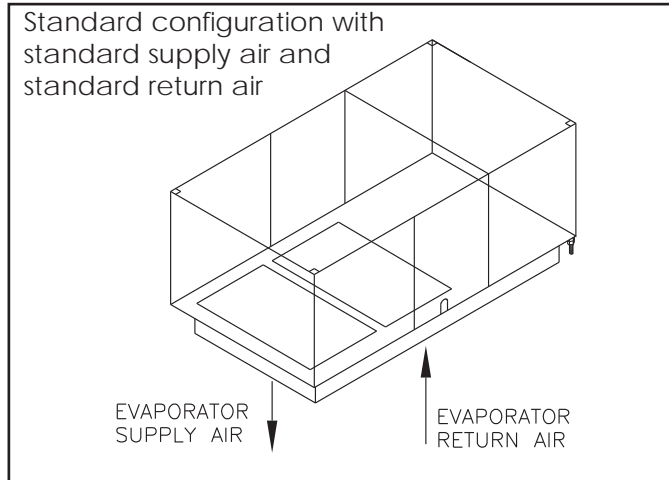

SPLIT SYSTEMS - *continued*

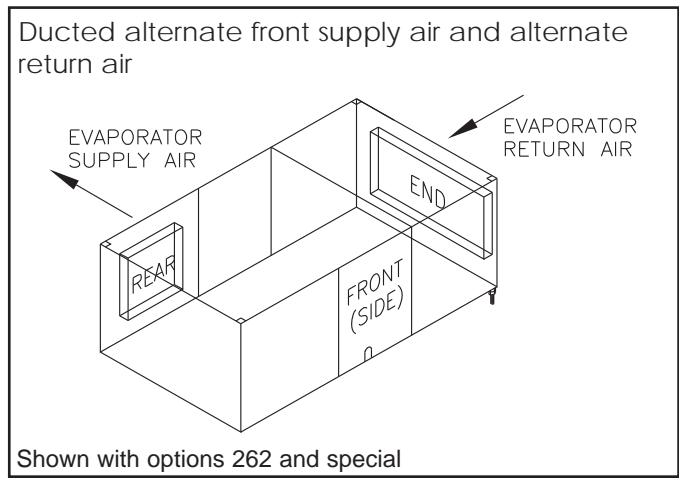
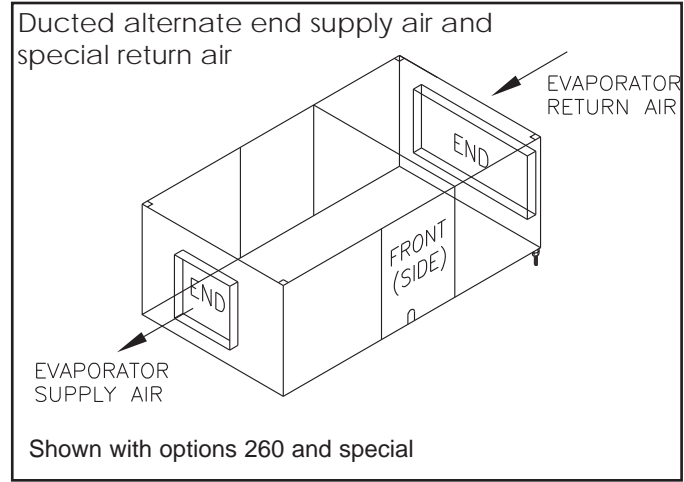
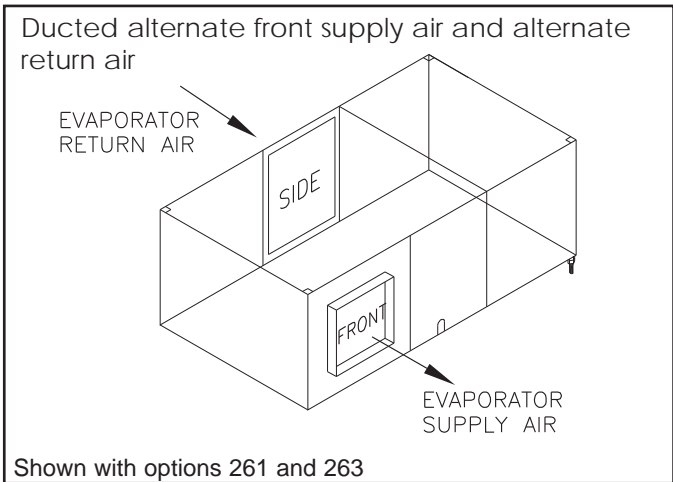
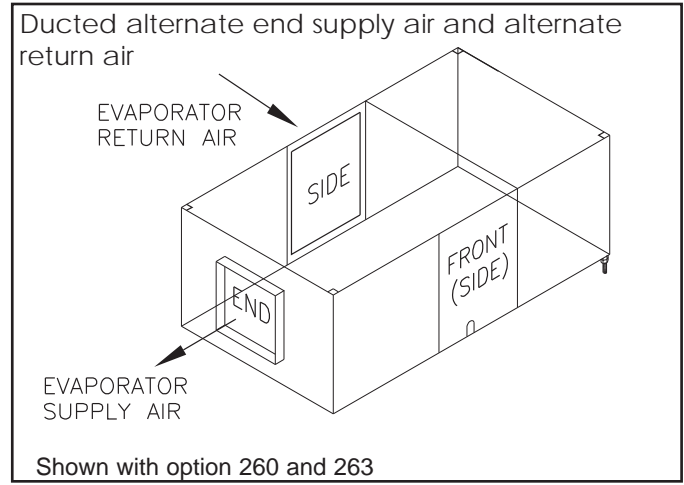
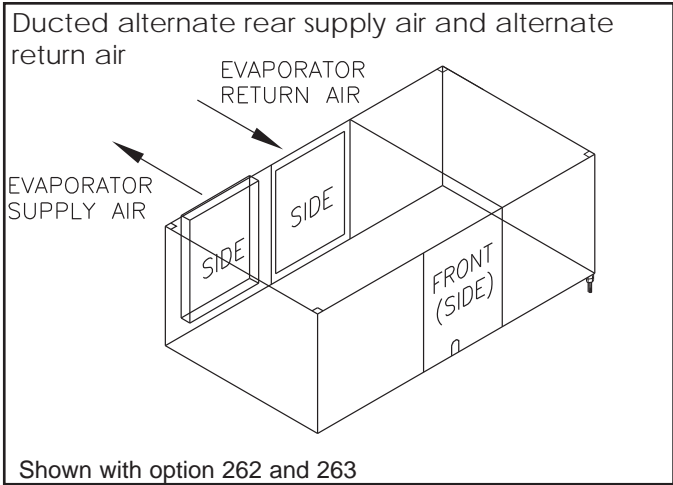

AIR COOLED: Performance data - R-407C

<i>MODEL NUMBER</i>		<i>DAMA-01</i>	<i>DAMA-1.5</i>	<i>DAMA-02</i>	<i>DAMA-2.5</i>
CAPACITY in Btu/hr - Gross					
80° DB/67° WB	Total	16,300	20,300	25,600	31,600
	50% RH Sensible	12,400	16,100	21,300	25,700
75° DB/62.5° WB	Total	15,100	18,800	23,700	29,300
	50% RH Sensible	12,000	15,600	20,600	24,800
75° DB/61° WB	Total	14,500	18,300	23,000	28,500
	45% RH Sensible	12,800	16,600	22,100	26,600
72° DB/60° WB	Total	14,300	17,900	22,600	27,900
	50% RH Sensible	11,800	15,200	20,100	24,300
72° DB/58.6° WB	Total	13,900	17,500	22,000	27,200
	45% RH Sensible	12,500	16,200	21,500	25,900

GLYCOL COOLED: Performance data - R-407C

<i>MODEL NUMBER</i>		<i>DAMG-01</i>	<i>DAMG-1.5</i>	<i>DAMG-02</i>	<i>DAMG-2.5</i>
CAPACITY in Btu/hr - Gross					
80° DB/67° WB	Total	15,900	19,800	25,200	31,000
	50% RH Sensible	12,300	15,900	21,200	25,500
75° DB/62.5° WB	Total	14,700	18,400	23,300	28,700
	50% RH Sensible	11,900	15,400	20,400	24,600
75° DB/61° WB	Total	14,200	17,900	22,500	27,900
	45% RH Sensible	12,700	16,500	21,800	26,400
72° DB/60° WB	Total	13,900	17,500	22,200	27,400
	50% RH Sensible	11,600	15,000	19,900	24,000
72° DB/58.6° WB	Total	13,600	17,100	21,400	26,600
	45% RH Sensible	12,400	16,100	21,100	25,700

WATER COOLED: Performance data - R-407C

<i>MODEL NUMBER</i>		<i>DAMW-01</i>	<i>DAMW-1.5</i>	<i>DAMW-02</i>	<i>DAMW-2.5</i>
CAPACITY in Btu/hr - Gross					
80° DB/67° WB	Total	17,100	21,100	26,700	32,900
	50% RH Sensible	12,700	16,400	21,700	26,200
75° DB/62.5° WB	Total	15,800	19,600	24,800	30,600
	50% RH Sensible	12,300	15,900	21,000	25,300
75° DB/61° WB	Total	15,200	19,000	24,100	29,800
	45% RH Sensible	13,100	17,000	22,500	27,200
72° DB/60° WB	Total	15,000	18,600	23,700	29,200
	50% RH Sensible	12,100	15,500	20,600	24,800
72° DB/58.6° WB	Total	14,400	18,200	23,100	28,500
	45% RH Sensible	12,800	16,500	21,900	26,500

AIR, GLYCOL and Water COOLED: Performance data

<i>MODEL NUMBER</i>	<i>DAM*-01</i>	<i>DAM*-1.5</i>	<i>DAM*-02</i>	<i>DAM*-2.5</i>
---------------------	----------------	-----------------	----------------	-----------------

EVAPORATOR BLOWER

Airflow - CFM	550	775	1000	1225
Standard motor - horsepower	1/2	1/2	3/4	3/4
External Static Pressure (E.S.P.) - inches of W.G.	0.5	0.5	0.5	0.5

EVAPORATOR COIL

Face area - sq ft	2.4	2.4	2.4	2.4
Face velocity - fpm	229	323	417	510
Rows of coil	3	3	4	4

CONDENSER COIL

Air cooled indoor packaged units

Face area - sq ft	2.4	2.4	2.4	2.4
Face velocity - fpm	500	500	500	500
Rows of coil	4	4	6	6

CONDENSER BLOWER

Air cooled indoor packaged units

Standard airflow - CFM	1,200	1,200	1,200	1,200
Standard motor - horsepower (208 V)	3/4	3/4	3/4	3/4
Standard motor - horsepower (277 V)	1/2	1/2	1/2	1/2
External Static Pressure (E.S.P.) - inches of W.G.	0.5	0.5	0.5	0.5

CONDENSER DATA

Water cooled units

Type	Plate-fin	Plate-fin	Plate-fin	Plate-fin
Water regulating valve	2-way	2-way	2-way	2-way
Size - inches	3/8	3/8	3/4	3/4
Maximum working pressure - PSI	150	150	150	150

ENTERING WATER

Water cooled units

Using 65° F EWT	GPM	1.2	1.9	2.5	3.1
	PD in PSI	1.3	2.9	2.1	3.0
Using 75° F EWT	GPM	2.0	3.0	3.9	4.9
	PD in PSI	2.0	4.3	3.1	4.5
Using 85° F EWT	GPM	2.8	4.2	5.6	7.0
	PD in PSI	3.0	6.7	4.8	6.9
With Fluid Cooler	GPM	3.5	5.3	7.0	8.8
	PD in PSI	5.8	12.4	9.2	13.3

COMPRESSOR DATA

Type	Scroll	Scroll	Scroll	Scroll
Quantity	1	1	1	1
Cooling stages	1	1	1	1
Refrigerant type	R-407C	R-407C	R-407C	R-407C
Crankcase heater	Standard	Standard	Standard	Standard

* Insert: A - Air cooled, G - Glycol cooled, W - Water cooled
R-407C

AIR, GLYCOL and Water COOLED: Performance data

MODEL NUMBER	DAM*-01	DAM*-1.5	DAM*-02	DAM*-2.5
REHEAT SECTION		<i>Optional</i>		
Type - Electric				
Capacity- kW	2	2	2	2
Btu/hr	6,830	6,830	6,830	6,830
Capacity - kW	4	4	4	4
Btu/hr	13,660	13,660	13,660	13,660
Capacity- kW	N/A	N/A	5	5
Btu/hr			17,075	17,075
HUMIDIFIER SECTION		<i>Optional</i>		
Type - Steam Generator				
Capacity - lb/hr	5	5	5	5
kW	1.7	1.7	1.7	1.7
FILTER SECTION				
Type	Pleated	Pleated	Pleated	Pleated
Quantity	1	1	1	1
Size - inches	20x20x2	20x20x2	20x20x2	20x20x2
Efficiency - MERV	8	8	8	8
(Note: Efficiency based on ASHRAE Std. 52.2)				
CONNECTION SIZES				
Condensate drain - fpt	3/4	3/4	3/4	3/4
Humidifier	1/4	1/4	1/4	1/4
With air cooled condensing unit:				
Liquid line - O.D. Copper	1/2	1/2	1/2	1/2
Suction line - O.D. Copper	3/4	3/4	3/4	3/4
With air cooled condenser:				
Liquid line - O.D. Copper	1/2	1/2	1/2	1/2
Hot gas line - O.D. Copper	1/2	1/2	1/2	1/2
Water and glycol cooled:				
Condenser water - In/Out	3/4	3/4	3/4	3/4

AIR COOLED: Electrical data

ELECTRICAL SECTION

AIR COOLED (Packaged Systems)

MODEL NUMBER		DAMA-01-P	DAMA-1.5-P	DAMA-02-P	DAMA-2.5-P
Electrical data based on: electric reheat - NO , steam generator humidifier - NO .					
208-230 V	FLA/MCA/MOP	19/22/30	19/22/30	22/25/35	24/28/40
277 V	FLA/MCA/MOP	15/17/20	15/17/20	17/19/25	19/22/30
Electrical data based on: electric reheat - NO , steam generator humidifier - YES .					
208-230 V	FLA/MCA/MOP	27/32/35	27/32/35	30/35/40	33/38/45
277 V	FLA/MCA/MOP	21/25/30	21/25/30	23/27/30	26/30/35
Electrical data based on: 2 kW electric reheat - YES , steam generator humidifier - YES .					
208-230 V	FLA/MCA/MOP	29/34/40	39/34/40	31/37/45	34/40/50
277 V	FLA/MCA/MOP	22/26/30	22/26/30	24/28/35	27/31/40
Electrical data based on: 4 kW electric reheat - YES , steam generator humidifier - YES .					
208-230 V	FLA/MCA/MOP	38/46/50	38/46/50	41/49/50	44/52/60
277 V	FLA/MCA/MOP	29/35/40	29/35/40	31/37/40	34/40/45
Electrical data based on: 2 kW electric reheat - YES , steam generator humidifier - NO .					
208-230 V	FLA/MCA/MOP	29/34/40	29/34/40	31/37/45	34/40/50
277 V	FLA/MCA/MOP	22/26/30	22/26/30	24/28/35	27/31/40
Electrical data based on: 4 kW electric reheat - YES , steam generator humidifier - NO .					
208-230 V	FLA/MCA/MOP	38/46/50	38/46/50	41/49/50	44/52/60
277 V	FLA/MCA/MOP	29/35/40	29/35/40	31/37/40	34/40/45

AIR COOLED (Split Systems with Outdoor Condensing Unit)

MODEL NUMBER		DAMA-01-AO	DAMA-1.5-AO	DAMA-02-AO	DAMA-2.5-AO
Electrical data based on: electric reheat - NO , steam generator humidifier - NO .					
208-230 V					
	Indoor FLA/MCA/MOP	4.0/5.0/15	4.0/5.0/15	5.3/6.6/15	5.3/6.6/15
	Outdoor FLA/MCA/MOP	12/14/20	14/17/25	16/18/25	18/22/35
277 V					
	Indoor FLA/MCA/MOP	3.6/4.5/15	3.6/4.5/15	4.3/5.4/15	4.3/5.4/15
Electrical data based on: electric reheat - NO , steam generator humidifier - YES .					
208-230 V					
	Indoor FLA/MCA/MOP	12/15/20	12/15/20	14/17/20	14/17/20
	Outdoor FLA/MCA/MOP	14/17/25	14/17/25	16/18/25	18/22/35
277 V					
	Indoor FLA/MCA/MOP	9.7/12/15	9.7/12/15	10/13/15	10/13/15

Note: Transformers are required to step from 277 volt to 208-230 volt on outdoor condensing units. 277 volt condensing units are not available.

AIR COOLED: Electrical data

AIR COOLED (Split Systems with Outdoor Condensing Unit)

MODEL NUMBER			DAMA-01-AO	DAMA-1.5-AO	DAMA-02-AO	DAMA-2.5-AO
Electrical data based on: 2 kW electric reheat - YES , steam generator humidifier - YES .						
208-230 V	Indoor	FLA/MCA/MOP	14/17/20	14/17/20	15/19/20	15/19/20
	Outdoor	FLA/MCA/MOP	14/17/25	14/17/25	16/18/25	18/22/35
277 V	Indoor	FLA/MCA/MOP	11/14/15	11/14/15	12/14/15	12/14/15
Electrical data based on: 4 kW electric reheat - YES , steam generator humidifier - YES .						
208-230 V	Indoor	FLA/MCA/MOP	23/29/30	23/29/30	25/31/35	25/31/35
	Outdoor	FLA/MCA/MOP	14/17/25	14/17/25	16/18/25	18/22/35
277 V	Indoor	FLA/MCA/MOP	18/23/25	18/23/25	19/23/25	19/23/25
Electrical data based on: 2 kW electric reheat - YES , steam generator humidifier - NO .						
208-230 V	Indoor	FLA/MCA/MOP	14/17/20	14/17/20	15/19/20	15/19/20
	Outdoor	FLA/MCA/MOP	14/17/25	14/17/25	16/18/25	18/22/35
277 V	Indoor	FLA/MCA/MOP	11/14/15	11/14/15	12/14/15	12/14/15
Electrical data based on: 4 kW electric reheat - YES , steam generator humidifier - NO .						
208-230 V	Indoor	FLA/MCA/MOP	23/29/30	23/29/30	25/31/35	25/31/35
	Outdoor	FLA/MCA/MOP	14/17/25	14/17/25	16/18/25	18/22/35
277 V	Indoor	FLA/MCA/MOP	18/23/25	18/23/25	19/23/25	19/23/25

Note: Transformers are required to step from 277 volt to 208-230 volt on outdoor condensing units. 277 volt condensing units are not available.

FLA - Full load amps **MCA** - Minimum circuit amps wire sizing amps **MOP** - Maximum rating of the Overcurrent Protective devices

AIR COOLED: Electrical data

AIR COOLED (Split Systems with Remote Air Cooled Condenser)

MODEL NUMBER			DAMA-01-CO	DAMA-1.5-CO	DAMA-02-CO	DAMA-2.5-CO
Electrical data based on: electric reheat - NO , steam generator humidifier - NO .						
208-230 V	Indoor	FLA/MCA/MOP	14/16/25	14/16/25	16/19/30	19/22/35
	Outdoor	FLA/MCA/MOP	4.6/5.8/15	4.6/5.8/15	4.6/5.8/15	4.6/5.8/15
277 V	Indoor	FLA/MCA/MOP	11/13/20	11/13/20	13/16/25	16/19/30
Electrical data based on: electric reheat - NO , steam generator humidifier - YES .						
208-230 V	Indoor	FLA/MCA/MOP	22/26/30	22/26/30	24/29/35	27/32/40
	Outdoor	FLA/MCA/MOP	4.6/5.8/15	4.6/5.8/15	4.6/5.8/15	4.6/5.8/15
277 V	Indoor	FLA/MCA/MOP	17/21/25	17/21/25	19/23/30	22/26/35
Electrical data based on: 2 kW electric reheat - YES , steam generator humidifier - YES .						
208-230 V	Indoor	FLA/MCA/MOP	23/28/35	23/28/35	26/31/35	28/34/45
	Outdoor	FLA/MCA/MOP	4.6/5.8/15	4.6/5.8/15	4.6/5.8/15	4.6/5.8/15
277 V	Indoor	FLA/MCA/MOP	19/22/25	19/22/25	21/25/30	23/28/35
Electrical data based on: 4 kW electric reheat - YES , steam generator humidifier - YES .						
208-230 V	Indoor	FLA/MCA/MOP	33/40/45	33/40/45	35/43/45	38/46/50
	Outdoor	FLA/MCA/MOP	4.6/5.8/15	4.6/5.8/15	4.6/5.8/15	4.6/5.8/15
277 V	Indoor	FLA/MCA/MOP	26/31/35	26/31/35	28/34/35	30/37/45
Electrical data based on: 2 kW electric reheat - YES , steam generator humidifier - NO .						
208-230 V	Indoor	FLA/MCA/MOP	23/28/35	23/28/35	26/31/35	28/34/45
	Outdoor	FLA/MCA/MOP	4.6/5.8/15	4.6/5.8/15	4.6/5.8/15	4.6/5.8/15
277 V	Indoor	FLA/MCA/MOP	19/22/25	19/22/25	21/25/30	23/28/35
Electrical data based on: 4 kW electric reheat - YES , steam generator humidifier - NO .						
208-230 V	Indoor	FLA/MCA/MOP	33/40/45	33/40/45	35/43/45	38/46/50
	Outdoor	FLA/MCA/MOP	4.6/5.8/15	4.6/5.8/15	4.6/5.8/15	4.6/5.8/15
277 V	Indoor	FLA/MCA/MOP	26/31/35	26/31/35	28/34/35	30/37/45

FLA - Full load amps **MCA** - Minimum circuit amps wire sizing amps **MOP** - Maximum rating of the Overcurrent Protective device

WATER or GLYCOL COOLED: Electrical data

WATER COOLED (Packaged Systems)

MODEL NUMBER		DAMW-01	DAMW-1.5	DAMW-02	DAMW-2.5
Electrical data based on: electric reheat - NO , steam generator humidifier - NO .					
208-230 V	FLA/MCA/MOP	14/16/20	14/16/20	16/19/25	16/19/30
277 V	FLA/MCA/MOP	11/13/20	11/13/20	13/16/25	13/16/25
Electrical data based on: electric reheat - NO , steam generator humidifier - YES .					
208-230 V	FLA/MCA/MOP	22/26/30	22/26/30	24/29/35	24/29/35
277 V	FLA/MCA/MOP	18/22/25	17/21/25	19/23/30	22/26/35
Electrical data based on: 2 kW electric reheat - YES , steam generator humidifier - YES .					
208-230 V	FLA/MCA/MOP	23/28/35	23/28/35	26/31/35	26/31/35
277 V	FLA/MCA/MOP	17/21/25	19/22/25	21/25/30	21/25/30
Electrical data based on: 4 kW electric reheat - YES , steam generator humidifier - YES .					
208-230 V	FLA/MCA/MOP	33/40/45	33/40/45	35/43/45	35/43/45
277 V	FLA/MCA/MOP	26/31/35	26/31/35	28/34/35	28/34/35
Electrical data based on: 2 kW electric reheat - YES , steam generator humidifier - NO .					
208-230 V	FLA/MCA/MOP	23/28/35	23/28/35	26/31/35	26/31/35
277 V	FLA/MCA/MOP	19/22/25	19/22/25	21/25/30	21/25/30
Electrical data based on: 4 kW electric reheat - YES , steam generator humidifier - NO .					
208-230 V	FLA/MCA/MOP	33/40/45	33/40/45	35/43/45	35/43/45
277 V	FLA/MCA/MOP	26/31/35	26/31/35	28/34/35	28/34/35

COMPRESSORS and MOTORS (DX Units, Air Cooled, and Water Cooled)

MODEL NUMBER		DAM*-01	DAM*-1.5	DAM*-02	DAM*-2.5
EVAPORATOR FAN MOTOR					
Standard motor - horsepower					
		1/2	1/2	3/4	3/4
	FLA at 208-230 V	4.0	4.0	5.3	5.3
	FLA at 277 V	3.6	3.6	4.3	4.3
CONDENSER FAN MOTOR					
<i>(Air Cooled Indoor Packaged Units)</i>					
Standard motor - horsepower (208 V)					
		3/4	3/4	3/4	3/4
	FLA at 208-230 V	5.6	5.6	5.6	5.6
Standard motor - horsepower (277 V)					
		1/2	1/2	1/2	1/2
	FLA at 277 V	3.6	3.6	3.6	3.6
CONDENSER FAN MOTOR					
<i>(Air Cooled Split Systems - Condensing Units or Air Cooled Condensers)</i>					
Standard motor - horsepower					
		3/4	3/4	3/4	3/4
	Motor FLA at 208-230 V	4.2	4.2	4.2	4.2
COMPRESSOR					
Standard motor - horsepower					
		1.5	1.5	2.0	2.5
	FLA at 208-230 V	9.6	9.6	10.9	13.5
	FLA at 277 V	7.7	7.7	9.0	11.5

FLA - Full load amps

MCA - Minimum circuit amps wire sizing amps

MOP - Maximum rating of the Overcurrent Protective device

CHILLED WATER: Performance data

<i>MODEL NUMBER</i>		<i>DAMC-01</i>	<i>DAMC-1.5</i>	<i>DAMC-02</i>	<i>DAMC-2.5</i>
CAPACITY in Btu/hr - Gross					
80° DB/67° WB	Total	15,800	21,300	28,700	33,900
50% RH	Sensible	12,200	16,500	22,400	26,600
75° DB/62.5° WB	Total	12,500	16,800	22,800	26,900
50% RH	Sensible	11,000	14,900	20,200	24,000
75° DB/61° WB	Total	11,900	16,000	21,700	25,600
45% RH	Sensible	11,400	15,400	21,000	24,900
72° DB/60° WB	Total	10,800	14,600	19,800	23,300
50% RH	Sensible	10,200	13,700	18,700	22,200
72° DB/58.6° WB	Total	10,500	14,100	19,200	22,700
45% RH	Sensible	10,400	14,000	19,200	22,700

Note: Chilled Water capacity based on 45° F entering chilled water temperature.

CHILLED WATER COIL

Face are - sq ft	2.4	2.4	2.4	2.4
Rows of coil	3	3	4	4
Face velocity - fpm	229	323	417	510

BLOWER SECTION

Airflow - cfm	550	775	1000	1225
Standard fan motor - hp	1/2	1/2	3/4	3/4
External Static Pressure (E.S.P.) - inches of W.G.	0.5	0.5	0.5	0.5
Number of fans	1	1	1	1

CHILLED WATER REQUIRED

(Maximum 150 PSI)

Using 45° F EWT

GPM	3.0	4.5	6.0	7.5
PSI	2.4	5.3	7.7	10.5

CHILLED WATER VALVE

Valve body	2-WAY	2-WAY	2-WAY	2-WAY
Valve size - inches	3/4	3/4	3/4	3/4

REHEAT SECTION

(Optional)

Electric

kW	2	2	2	2
Btu/hr	6,825	6,825	6,825	6,825
kW	4	4	4	4
Btu/hr	13,650	13,650	13,650	13,650
kW	N/A	N/A	5	5
Btu/hr	N/A	N/A	17,075	17,075

HUMIDIFIER SECTION

(Optional)

Steam generator

Capacity - lbs/hr	5	5	5	5
kW	1.7	1.7	1.7	1.7

CHILLED WATER: Performance data

<i>MODEL NUMBER</i>	<i>DAMC-01</i>	<i>DAMC-1.5</i>	<i>DAMC-02</i>	<i>DAMC-2.5</i>
---------------------	----------------	-----------------	----------------	-----------------

FILTER SECTION

Type	Pleated	Pleated	Pleated	Pleated
Quantity	1	1	1	1
Size - inches	20x20x2	20x20x2	20x20x2	20x20x2
Efficiency - MERV	8	8	8	8

(Note: Efficiency based on ASHRAE Std. 52.2)

CONNECTION SIZES

Chilled water in/out				
O.D. copper	3/4	3/4	3/4	3/4
Condensate drain - FPT	3/4	3/4	3/4	3/4
Humidifier	1/4	1/4	1/4	1/4

ELECTRICAL SECTION

Electrical data based on: electric reheat - **NO**, steam generator humidifier - **NO**.

208-230 V	FLA/MCA/MOP	4.0/5.0/15	4.0/5.0/15	5.3/6.6/15	5.3/6.6/15
277 V	FLA/MCA/MOP	3.6/4.5/15	3.6/4.5/15	4.3/5.4/15	4.3/5.4/15

Electrical data based on: electric reheat - **NO**, steam generator humidifier - **YES**.

208-230 V	FLA/MCA/MOP	12/15/20	12/15/20	14/17/20	14/17/20
277 V	FLA/MCA/MOP	9.7/12/15	10/13/15	10/13/15	

Electrical data based on: 2 kW electric reheat - **YES**, steam generator humidifier - **YES**.

208-230 V	FLA/MCA/MOP	14/17/20	14/17/20	15/19/20	15/19/20
277 V	FLA/MCA/MOP	11/14/15	11/14/15	12/14/15	12/14/15

Electrical data based on: 4 kW electric reheat - **YES**, steam generator humidifier - **YES**.

208-230 V	FLA/MCA/MOP	23/29/30	23/29/30	25/31/35	25/31/35
277 V	FLA/MCA/MOP	18/23/25	18/23/25	19/23/25	19/23/25

Electrical data based on: 2 kW electric reheat - **YES**, steam generator humidifier - **NO**.

208-230 V	FLA/MCA/MOP	14/17/20	14/17/20	15/19/20	15/19/20
277 V	FLA/MCA/MOP	11/14/15	11/14/15	12/14/15	12/14/15

Electrical data based on: 4 kW electric reheat - **YES**, steam generator humidifier - **NO**.

208-230 V	FLA/MCA/MOP	23/29/30	23/29/30	26/31/35	26/31/35
277 V	FLA/MCA/MOP	18/23/25	18/23/25	19/23/25	19/23/25

BLOWER SECTION

Standard motor - hp	1/2	1/2	3/4	3/4
FLA at 208-230 V	3.5	3.5	5.3	5.3
FLA at 277 V	3.4	3.4	4.3	4.3

FLA - Full load amps

MCA - Minimum circuit amps wire sizing amps

MOP - Maximum rating of the Overcurrent Protective device

	Weights - lbs							
	<i>Operational</i>				<i>Shipping</i>			
	1.0	1.5	2.0	2.5	1.0	1.5	2.0	2.5
<u>Packaged Systems</u>								
Air Cooled	425	425	425	425	450	450	450	450
Water Cooled	350	350	350	350	375	375	375	375
Chilled Water	300	300	300	300	325	325	325	325
<u>Split Systems*</u>								
Air Cooled - AO	280/300	280/300	280/300	280/300	305/340	305/340	305/340	305/340
Air Cooled - CO	325/260	325/260	325/260	325/260	350/300	350/300	350/300	350/300
* Weights provided are for the evaporator section (inside-first number) and condensing or condenser section (outside-second number). Each section shipped separately. Weights shown are for standard units.								



230 W. BlueRidge Avenue
Orange CA 92865
800-347-2473

www.dataaire.com e-mail: sales@dataaire.com

A Member of the CS Group of Companies
© 2010 Data Aire Inc.

Data Aire, Inc. reserves the right to make design changes for the purposes of product improvement, or to withdraw any design without notice.

DAMCS-R-407C - 0810 Rev F

