

Mini-Plus Ceiling Systems

Air, Water and Glycol Cooled DX and Chilled Water

Installation, Operation & Maintenance Manual



Data Aire, Inc.

230 W. BlueRidge Avenue

Orange, CA 92865

www.dataaire.com

dataaire
Precise by Design

CONGRATULATIONS ON THE SELECTION OF A DATA AIRE PRECISION ENVIRONMENTAL CONTROL SYSTEM. PROPER INSTALLATION, OPERATION AND MAINTENANCE OF THIS EQUIPMENT WILL ENSURE YEARS OF OPTIMAL PERFORMANCE.

There are separate User Manuals for other components of your Data Aire precision environmental cooling system including dap4™, condenser/condensing unit and fluid cooler.



NOTE: This manual is intended to assist trained service personnel by providing necessary guidelines for this particular equipment. Service to Data Aire units should be done by qualified individuals with an adequate background in areas such as HVAC, electrical, plumbing and electronics, as applicable.



WARNING: Service performed by unauthorized or unqualified technicians may void manufacturers' warranties and could result in property damage and/or personal injury.



NOTE: Special care should be given to those areas where these symbols appear.

Data Aire, Inc. reserves the right to make design changes for the purpose of product improvement or to withdraw any design without notice.

Table of Contents

1.0	Installation.....	6
1.1	Room Considerations	6
1.2	Inspection	6
1.3	Locating the Unit.....	6
1.3.1	Horizontal Airflow Units.....	7
1.3.2	Vertical Airflow Units	7
1.3.3	Indoor Condensers and Condensing Units.....	7
1.4	Paper work.....	8
1.5	Storage	8
1.6	Model Identification.....	9
2.0	Piping	10
2.1	Split Aire Cooled Unit Piping.....	10
2.1.1	Discharge Lines.....	10
2.1.2	Liquid Lines.....	11
2.1.3	Suction Lines	12
2.1.4	Connection Sizes, Aire Cooled Units.....	12
2.1.5	Field Piping, Remote Condenser/ Condensing Unit Above Evaporator	12
2.1.6	Field Piping, Remote Condenser/ Condensing Unit Below Evaporator	12
2.2	Water/Glycol Unit Piping.....	13
2.2.1	Field Piping, Water/Glycol System	13
2.2.2	Connection Sizes, Water/Glycol Cooled Units.....	14
2.2.3	Connection Sizes, Fluid Coolers (Dry Coolers).....	14
2.3	Auxiliary Chilled Water Coil Pipings.....	14
2.4	Condensate Drain System.....	15
2.5	Condensate Trap	15
2.6	Humidifier Piping.....	16
2.7	Leak Testing.....	17
2.8	Evacuation	17
3.0	Electrical Connections	18
3.1	Electrical Service	18
3.2	Nameplate Ratings	18
3.3	Grounding	18
3.4	Voltage Tolerance	18
3.5	Auxiliary Control Wiring.....	18
3.6	Remote Shutdown	20
3.7	Remote Alarm Contacts.....	20

3.7.1 Mini dap4 Microprocessor Controller.....	20
3.8 Remote Sensors	20
3.8.1 Mini dap4 Microprocessor Controller	20
3.9 Condensate Pumps.....	20
4.0 Installation of Remote Outdoor Heat Exchanger.....	21
4.1 Rigging.....	21
4.2 Leg Assembly.....	21
4.3 Locating the Remote Heat Exchanger	21
4.4 Electrical Service	22
4.5 Air Cooled Condensers - Model DARC.....	22
4.5.1 Fan Speed Control.....	22
4.5.2 Ambient Thermostat.....	22
4.6 Fluid Coolers - Model DAFC	23
4.6.1 Fluid-Sensing Thermostats	23
4.6.2 Energy Saver Cooling.....	23
5.0 Charging.....	24
5.1 Voltage Phase Check.....	24
5.1.1 Evaporator	24
5.1.2 Secondary Heat Exchanger.....	24
5.2 Air Cooled Systems.....	24
5.2.1 Packaged Aire Cooled Systems.....	24
5.2.2 Split Indoor Air Cooled Systems Charging.....	25
5.2.3 Fan Speed Control System Charging	26
5.2.4 Flooded System Charging	27
5.3 Water/Glycol Cooled Systems	28
5.3.1 Water/Glycol Cooled System Charging	28
5.3.2 Factory Charge for Water/Glycol Cooled Systems	28
5.4 Refrigerant Handling	28
5.5 Important Refrigeration Components.....	29
5.5.1 Expansion Valve	29
5.5.2 High Pressure Cutout Switch.....	29
5.5.3 Low Pressure Cutout Switch.....	29
6.0 Glycol Systems	30
6.1 Glycol Concentration.....	30
6.2 Internal (Fluid) Volume.....	30
6.3 Fluid Cooler Internal Volume.....	30
6.4 Copper Piping Internal Volume	30
6.5 Freezing Point of Aqueous Solutions	31

7.0 Controls.....	32
7.1 Mini dap4 Microprocessor Control Panel.....	32
7.2 Optional Expanded dap4	32
7.3 Optional Thermostat	32
7.4 Optional Programmable Thermostat.....	32
7.5 Wiring Diagrams.....	32
8.0 Regular Maintenance Items	33
8.1 Air Filters	33
8.2 Belts	33
8.3 Bearings.....	33
8.4 Humidifier Canisters.....	33
8.5 Fuses.....	34
8.6 Heating Elements.....	34
8.7 Refrigerant Filter Drier	34
9.0 Warranty Policy	35
10.0 Contact Data Aire.....	36
Recommended Line Sizing for Aire Cooled Split Systems.....	37
Temperature Pressure Chart.....	38
Superheat and Suction Pressure Troubleshooting Guide	39
Maintenance/Inspection Check List.....	40

1.0 INSTALLATION



WARNING: There is no intent on the part of Data Aire, Inc. to define local codes and statutes which may supercede common trade practices. The manufacturer assumes no responsibility for their interpretation. Consult local building codes and the National Electrical Code for special installation requirements.

1.1 Room Considerations

Precision air conditioning equipment is designed to control spaces within close tolerances of temperature and humidity. However, the room must be built with a proper vapor barrier. A film of polyethylene is often used on walls and ceilings. Floors must be painted with vapor seal paint. All doors to the controlled space should be equipped with weather seals to prevent the infiltration of non-neutral conditioned air from entering the space. Failure to provide a vapor barrier can compromise the ability to control space conditions.

Introduction of outside air into the controlled space should be minimized. Outside air in excess of 5% of the total circulated air volume can have a significant effect on the overall space conditions and result in poor space control. All outside air that is introduced should be conditioned to the humidity and temperature parameters of the computer room air conditioned (CRAC) unit setpoints to maintain the room's design conditions.

1.2 Inspection

This equipment has been factory run-tested and has gone through a comprehensive inspection prior to its packaging and shipment to ensure that it arrives in excellent condition. However, shipping damage can occur and a visual inspection of the outer crating immediately upon delivery should be performed.

Note any external damage or other transportation damage on the freight carrier's forms. Inspect the unit itself for internal damage. A claim should be filed with the shipping company if the equipment is damaged or incomplete.

Loose items such as a remote control panel, disconnect switch handle and spare belts are packed inside the unit. Refer to the yellow shipping tag located on the electrical section panel.



WARNING: Freight damage claims are the responsibility of the purchaser. Action to recover losses should be filed immediately. Please notify Data Aire of any claims.

1.3 Locating the Unit

The unit is intended for above the ceiling installation and is typically suspended from structural members in the building above the ceiling. Add a 50% safety factor to the weight of the unit to determine the strength of the supporting structural members.

Appropriate service access above the ceiling is required around all service and electrical access panels. There must be unobstructed clearance below the unit allowing ladder access to enable routine maintenance and service.



NOTE: There are many available unit configurations for Mini-Plus Ceiling systems. Be sure to identify the unit type and style before installing. There may be split condenser and condensing units that require separate or shared power.



NOTE: Condensation formation and frequent humidifier flushing (units with humidifier) are normal functions of this equipment. Drain connections must be made to ensure proper water removal. Unit will require drain connections for condensate removal and water connections for humidifier make-up water, chilled water and/or hot water. Installation above equipment that could sustain water damage should be avoided.

1.3.1 Horizontal Airflow Units

Mini-Plus ceiling units with horizontal airflow configuration have a 24” evaporator section. Ductwork is connected to factory provided duct collars on the supply and return air openings.

Four threaded support rods must be securely attached to the building structure. Raise the evaporator section with an appropriate lifting device. Attach washers, nuts and nut jams to each threaded rod. Tighten the nut so the weight is supported evenly by the four rods and the unit is level.

1.3.2 Vertical Airflow Units

The evaporator sections with optional vertical airflow (available on 2.5 and 3 ton units only) are 28.5” high and are typically mounted over a standard 2’ x 4’ T-bar ceiling grid supported by four threaded rods.

Four threaded support rods must be securely attached to the building structure. Raise the evaporator section with an appropriate lifting device. Attach washers, nuts and nut jams to each threaded rod. Tighten the nut so the weight is supported evenly by the four rods and the unit is level. Be certain to allow for the depth of the supply/return air plenum when figuring the height of the unit in the ceiling space.

The 5” tall vertical supply/return plenum assembly is attached to the bottom of the evaporator section once the evaporator section is installed. Six screws fasten the plenum to the evaporator section. The supply/return air grilles should be temporarily removed for access during installation. The plenum typically mounts flush to the ceiling grid (depending on available space above unit).

1.3.3 Indoor Condensers and Condensing Units

Air cooled units are available with either an indoor condenser section or an indoor condensing unit (units are also available with remote outdoor condenser or condensing units – outdoor sections have their own installation, operation and maintenance manuals). Air cooled condensers and

condensing units have factory provided duct collars on the supply and intake air openings (split water cooling condensing units do not have airflow connections). Filters are recommended prior to the condenser coil when outside air is ducted to the condenser intake.

Four threaded support rods must be securely attached to the building structure. Raise the evaporator section with an appropriate lifting device. Attach washers, nuts and nut jams to each threaded rod. Tighten the nut so the weight is supported evenly by the four rods and the unit is level.

Typical installations have the indoor condenser or indoor condensing unit near or adjacent to the evaporator section especially when shared electrical power is required. The same service and maintenance requirements apply to these units as well.

1.4 Paperwork

Each Data Aire unit ships with start-up sheets that must be completed. The start-up sheets are enclosed in a packet with the unit. The packet includes the warranty certificate, wiring diagrams, specific component literature, warranty registration card and a copy of the unit's Installation/Operation and Maintenance manual.

A manila tag is attached to the outside panel to indicate articles that have been packaged and shipped loose within the unit cabinet.



NOTE: It is the responsibility of the start-up service company to return the start-up sheets and warranty registration card to Data Aire for activation of the unit warranty. Failure to do so may cause delays in warranty related services and in some cases void the warranty.

1.5 Storage

Your Data Aire equipment comes ready for immediate installation. In some instances it may be necessary to store the equipment for a period of time. If you must store the equipment it should be done in a dry area, out of the weather, protected from damage by other equipment in storage or transportation equipment, never stacked and avoid frequent relocation.

If equipment is stored for longer than 30 days special precautions must be taken to avoid coil damage. All coils should be charged and sealed with a low pressure (less than 25 PSIG) inert gas, such as nitrogen. This prevents contaminants from entering the coils. When the seal is broken at installation, the rush of escaping gas verifies the coil is still leak free. If coils are not charged and sealed, condensation mixes with air pollutants forming a weak acid and over time can cause pin-hole leaks to develop in coil tubes.

When equipment is installed after storage, caution should be taken to inspect and replace, if required, rubber hoses and belts. All moving parts, such as blowers and motors, should be hand tested to ensure they are free and clear prior to start-up. Finally, verify that all lubrication is fresh and full.

1.6 Model Identification

MINI-PLUS CEILING SYSTEMS

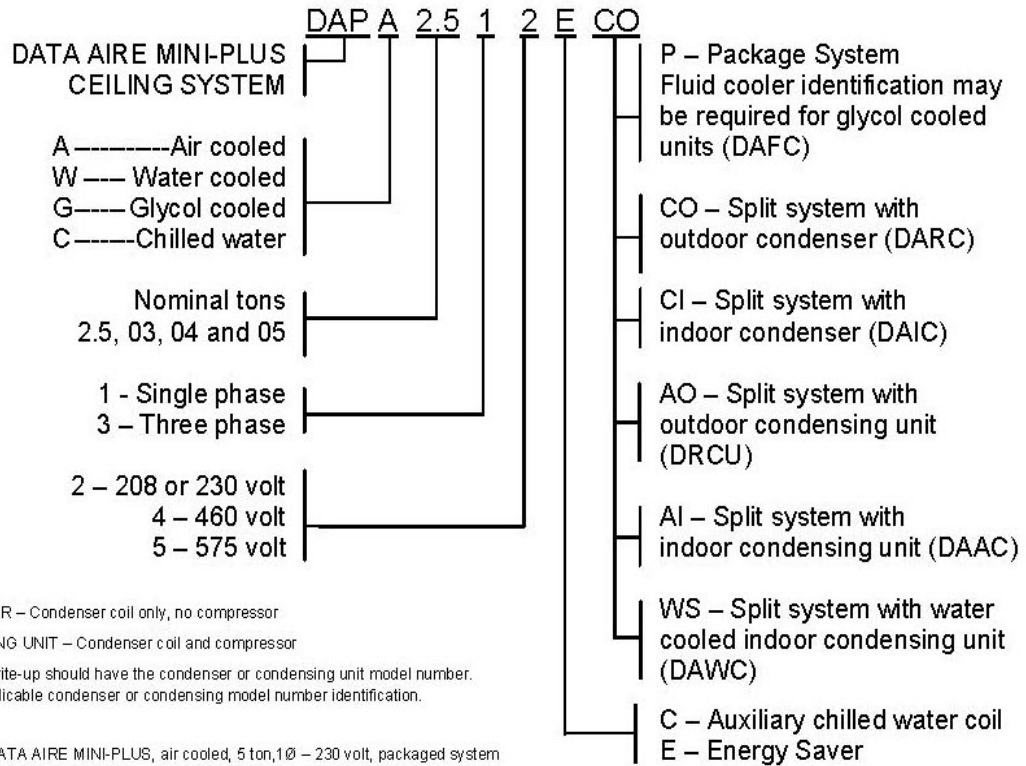

CONDENSER - Condenser coil only, no compressor

CONDENSING UNIT - Condenser coil and compressor

The order write-up should have the condenser or condensing unit model number. Refer to applicable condenser or condensing model number identification.

Example: DATA AIRE MINI-PLUS, air cooled, 5 ton, 1Ø - 230 volt, packaged system
With outdoor condensing unit - Evaporator Model: **DAPA 0512 AO**
Condensing Unit Model: **DRCU 0512**

2.0 PIPING

2.1 Split Air Cooled Unit Piping

Refer to the attached line sizing chart on page 36 for a guideline for sizing refrigerant lines. The ultimate responsibility for line sizing selection is that of the installing contractor or the design engineer. Data Aire does not assume this responsibility. The chart covers distances up to 200 equivalent feet. For installations greater than this distance, consult ASHRAE or similar references.

Standard piping practices must be used to ensure proper oil return and efficient operation. The interconnecting lines to the remote air cooled condenser or condensing unit must be installed by a qualified refrigeration mechanic.

2.1.1 Discharge Lines

Discharge lines, also called hot gas lines, should be trapped at the top (inverted) and bottom, as well as every 15 to 20 feet (4.6 to 6.1 m) of vertical rise. Discharge line check valves are required on all installations, especially those where there are long pipe runs or cold climates. For air-cooled units built after 3/14/2017, the discharge check valves are already installed inside the evaporator section and do not need to be installed external to the unit. For units built before this date, the check valves must be field supplied and installed externally to the evaporator section. If there is doubt as to whether or not the check valve is already installed in the unit, look for it on the hot gas line close to the exit point of the unit (see example picture below). The externally installed check valve should be placed from six (6) to ten (10) feet (1.8 to 3.1 m) from the compressor.



Note: Picture is only intended to show an example of a common check valve installation. It may not represent your specific unit, check valve size, location or orientation.

Data Aire recommends a silver/phosphorus/copper alloy with 5 to 15% silver to be used to braze the refrigerant line sets to the indoor and outdoor units. Nitrogen needs to be flowing through the lines to eliminate carbon deposit build-up of the joints. Carbon could contaminate the refrigerant and restrict the metering device.

Piping must be supported within 18" of the inlet and outlet connections. The inlet connection is located on the top header of all units. The discharge outlet is located at the bottom of the header.

The discharge line pressure drop should not exceed 6 PSIG (41 kPa) for R-407C and 9 PSIG (62 kPa) for R-410A. Recommended gas velocity for proper oil return is 1,000 FPM (5.1 m/sec). Slope horizontal lines downward in the direction of refrigerant flow, 1/2" (12 mm) for every 10 feet (3 m) of line length.

Discharge lines do not require insulation but due to the high temperatures of the refrigerant inside the line, the pipes may be insulated to protect against burns to individuals near or around the lines.

2.1.2 Liquid Lines

Liquid lines are determined by pressure drop and velocity. The liquid line pressure drop for R407C should not exceed 5 PSIG. For systems with R-410A, the pressure drop should not exceed 9 PSIG. The recommended velocity should be between 200 and 300 FPM. To avoid excessive liquid line pressure drop, the air cooled condenser should be located above or at the same level as the evaporator. Condenser installations more than 15 feet below the evaporator are not recommended. Insulation of liquid lines is not required but can be useful in preventing excessive sub-cooling or flashing on long exposed pipe runs.

2.1.3 Suction Lines

Some applications call for the compressor to be mounted as part of the condenser, more commonly referred to as a condensing unit. Such require field piping of liquid and suction lines. Suction lines are trapped similarly to discharge lines. Common practice for suction line selection and installation should be followed. Suction lines should always be insulated.

2.1.4 Connection Sizes, Air Cooled Units

MODEL	HOT GAS LINE	LIQUID LINE	SUCTION LINE
DAPA-2.5	1/2"	1/2"	3/4"
DAPA-03	1/2"	1/2"	3/4"
DAPA-04	1/2"	1/2"	3/4"
DAPA-05	1/2"	1/2"	3/4"

Note: Units will have a liquid line and either a hot gas or suction line

Field connections at the indoor evaporator and remote condenser or condensing unit will not necessarily be the same as the field pipe size required. In some cases these sizes will vary significantly.

2.1.5 Field Piping, Remote Condenser

NOTES:

1. THIS IS THE RECOMMENDED PIPING. ALL PIPING TO BE PER LOCAL AND/OR STATE CODE.
 2. CONDENSER TO BE NO MORE THAN 60 FEET ABOVE EVAPORATOR.
 3. FOR UNITS BUILT AFTER APRIL 2017, THE CHECK VALVES ARE INCLUDED INTERNALLY IN THE EVAPORATOR SECTION.
- △ SLOPE HORIZONTAL LINES DOWNWARD IN THE DIRECTION OF THE REFRIGERANT FLOW, 1/8" FOR EVERY 10 FEET OF LINE LENGTH.
- △ INVERTED TRAP TO EXTEND 8" ABOVE THE BOTTOM OF THE CONDENSER COIL.

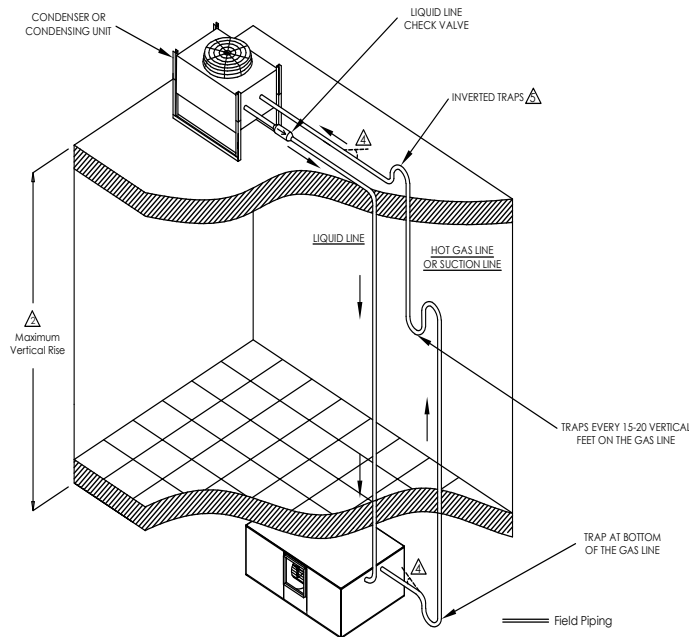

IT

2.1.6 Field Piping, Remote Condensing Unit

NOTES:

1. THIS IS THE RECOMMENDED PIPING. ALL PIPING TO BE PER LOCAL AND/OR STATE CODE.
 2. CONDENSER TO BE NO MORE THAN 15 FEET BELOW EVAPORATOR.
- ▲ SLOPE HORIZONTAL LINES DOWNWARD IN THE DIRECTION OF THE REFRIGERANT FLOW. 1/8" FOR EVERY 10 FEET OF LINE LENGTH.
- ▲ INVERTED TRAP NEEDED ON SUCTION LINE WHEN COMPRESSOR IS OUTDOORS ONLY.

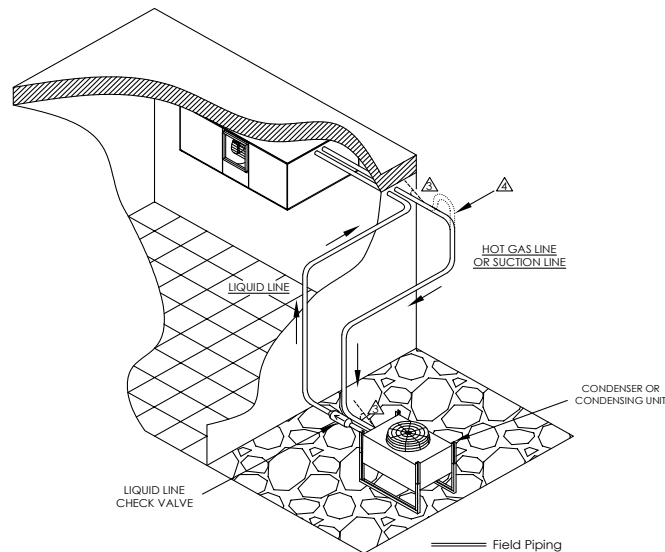

2.2 Water/Glycol Unit Piping

The required field installed condenser water pipe sizes may or may not be the same as the connection sizes at the evaporator section or fluid cooler (refer to Sections 2.2.2 and 2.2.3 for connection sizes). Water pipe sizes will depend on the length of pipe required and the calculated pressure drop of peripheral components.

Water cooled units may also be connected to building water or tower water sources. Pipe size will depend on length of run and the maximum water flow required.

All water/glycol units are shipped with plate/fin heat exchangers as standard equipment. A strainer is shipped loose and is to be field installed in the supply line with shut-off valves (field provided) before and after the strainer. The strainers and water/glycol piping must be cleaned on a periodic basis. If the unit is shipped with optional shell and tube condenser, strainers are not required nor shipped with the unit.

All water pipes have a cap installed on the end of the pipe for pressure testing the system. These caps need to be removed before installing the water piping to the unit. Use a tube cutter for smaller pipes and a reciprocating saw with a metal cutting blade for larger pipe sizes or if there is a clearance problem. All connections need to be cleaned before connections are brazed together.



NOTE: One of the most common problems in a water/glycol system is the presence of air in the condenser loop. Air vents must be installed in various locations in the piping system to purge the air.

Water/Glycol system piping may include a centrifugal pump (or pumps for redundancy). Pumps must be primed before operating per the pump manufacturer's guidelines.

2.2.1 Field Piping, Water/Glycol System

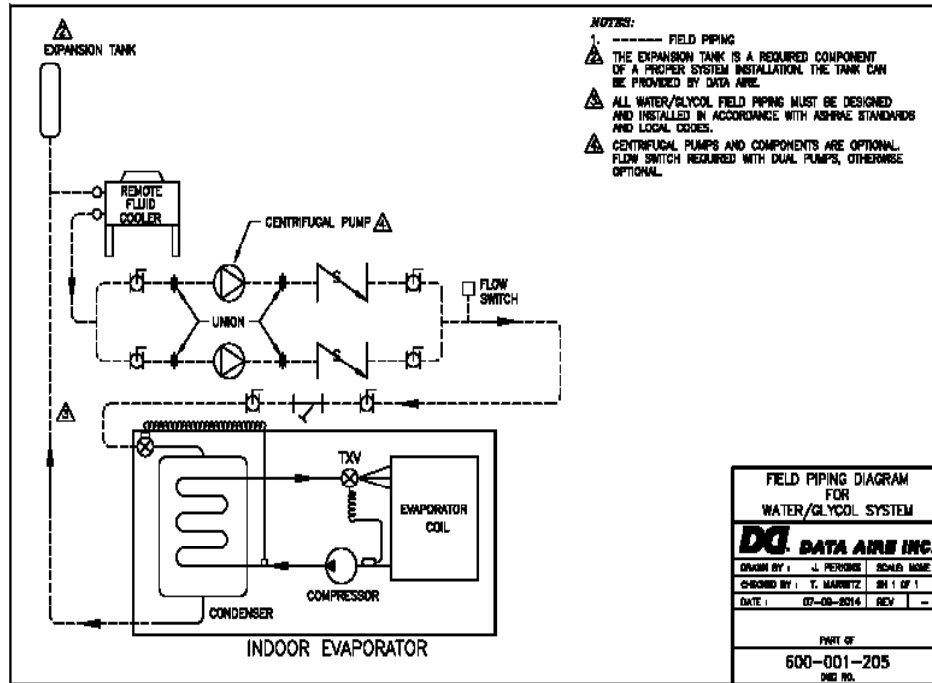

2.2.2 Connection Sizes, Water/Glycol Cooled Units

EVAPORATOR MODEL	WATER IN CONNECTION	WATER OUT CONNECTION
DAPW/G-2.5	3/4" O.D.	3/4" O.D.
DAPW/G-03	3/4" O.D.	3/4" O.D.
DAPW/G-04	1-1/8" O.D.	1-1/8" O.D.
DAPW/G-05	1-1/8" O.D.	1-1/8" O.D.

2.2.3 Connection Sizes, Fluid Coolers (Dry Coolers)

EVAPORATOR MODEL	WATER IN CONNECTION	WATER OUT CONNECTION
DAFC-06	1-5/8" O.D.	1-5/8" O.D.
DAFC-07	1-5/8" O.D.	1-5/8" O.D.
DAFC-09	1-5/8" O.D.	1-5/8" O.D.
DAFC-11	2-1/8" O.D.	2-1/8" O.D.
DAFC-15	2-1/8" O.D.	2-1/8" O.D.
DAFC-17	2-1/8" O.D.	2-1/8" O.D.

2.3 Auxiliary Chilled Water Coil Piping

Units with an optional Auxiliary Chilled Water cooling coil require a separate source of chilled water. The chilled water connection sizes will be the same as those listed for the condenser water (see chart in Section 2.2.3). Units with optional Energy Saver coil typically have shared or common piping with the condenser supply and therefore do not require a separate cooling source.

All chilled water pipes have a cap installed on the end of the pipe for pressure testing the system. These caps need to be removed before installing the water piping to the unit. Use a tube cutter for smaller pipes and a reciprocating saw with a metal cutting blade for larger pipe sizes or if there is a clearance problem. All connections need to be cleaned before connections are brazed together.



NOTE: Mini-Plus ceiling units with optional Energy Saver or Auxiliary Chilled Water coils have a 28-1/2" frame height instead of the standard 24" height.

2.4 Condensate Drain System

To properly drain the condensate from the ceiling evaporator condensate pan, the evaporator section is equipped with a 3/4" FPT connection on the bottom of the unit for condensate removal. The following are recommendation for condensate drain systems:

1. Do not reduce the size of the condensate drain piping.
2. The condensate drain piping must be run to an unrestricted waste line and must be protected from freezing.
3. In high humidity conditions it is recommended to insulate the condensate drain line to prevent condensation forming on the exterior of the piping.
4. It is recommended that a union (field supplied) be installed at the 3/4" FPT connection to permit easy disassembly of the condensate drain piping from the unit for cleaning.
5. Drain lines should be pitched downward not less than 1/4" for each ten (10) feet of horizontal run.
6. Where local codes permit, PVC pipe may be used.
7. Ceiling units with an optional vertical discharge have a 5" plenum below the evaporator drain pan. The plenum has knockouts that allow routing of the field supplied and installed condensate drain piping system. The drain line can be routed out either side of these units.

2.5 Condensate Trap

Probably the most misunderstood portion of a condensate drain system is trap installation. The primary purpose of a condensate trap is to prevent air from being drawn back into the unit during operation. Traps must be installed in a manner that will stop the air from passing through, but still allow the condensate to drain from the condensate pan.

Therefore, a trap (field supplied and installed) must be fabricated into the ceiling unit drain system external of the evaporator section. In order to eliminate air trapping, an air vent must be used to allow air to exit. Venting the drain after the first trap is recommended.

Figure 1 shows the recommended dimensions for fabricating a proper trap:

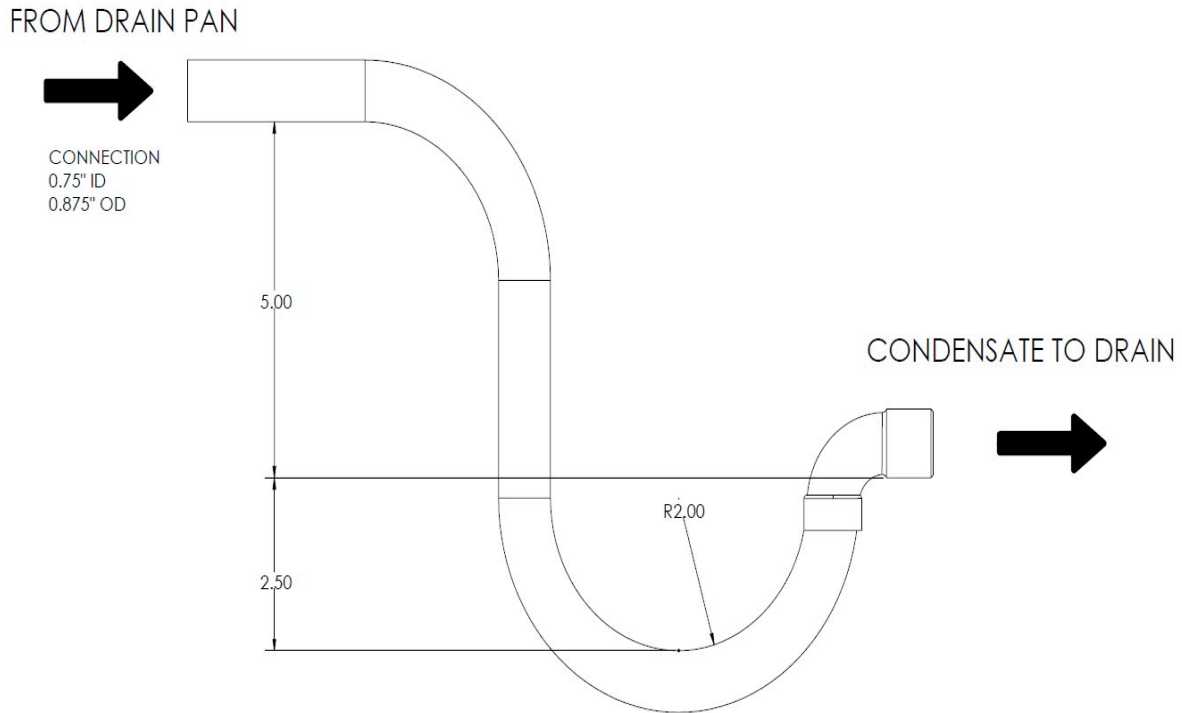

Figure 1 Recommended Condensate Trap Dimensions

Notes:

1. This trap is capable of handling static pressures equal to 4" H₂O which is the maximum static available for ceiling units. If the unit fans are standard, there is no need to consider different dimensions but if higher total static pressure is expected, more vertical drop is required.
2. Some applications have no convenient means of allowing a gravity drain. In this case, a condensate pump can be used. These come either factory mounted or shipped loose. Factory mounted condensate pumps do not require a separate power source.
3. Condensate pumps that ship loose or are field provided, typically require a dedicated 110 volt power source. Field pipe connections must be made to the pump discharge connection. A check valve must be installed to prevent short cycling. Pumps must be located below the condensate drain pan level.

2.6 Humidifier Piping

The optional humidifier on Mini-Plus Ceiling systems is a steam generator type with disposable cylinder. The humidifier make-up water should be brought to the humidifier through the field connection opening using 1/4" copper tubing. A compression fitting is provided at the humidifier. A shuf-off valve should be provided outside the unit to allow disconnection of service. An in-line water pressure regulator and strainer should be installed. Water pressure should be set between 30 and 80 PSI.

The humidifier has a drain at the bottom which is factory piped to the main condensate drain line. The dispersion tube also has a drain line. No additional field piping is required.

2.7 Leak Testing

No installation is complete until the entire system has been thoroughly checked for leaks. This includes checking refrigerant tubing, flare fittings, pressure controls, schrader fittings and compressor rotolock service valves. Check both field and factory connections.

In addition to the refrigeration system, check all condenser water lines, humidifier make-up lines, condensate lines, condensate pumps, chilled water lines, centrifugal pumps and fluid coolers as applicable.

When handling or recovering refrigerant it is not permissible to release refrigerant into the atmosphere. Many leak-test methods recommended in the past are no longer possible. Current standard practices must be used.

Pressurize system circuit to 150 PSIG (1034 kPa) by using dry nitrogen with a trace of refrigerant. Check the entire system for leaks with suitable leak finder (per local code) including but limited to all braze joints, caps, fittings and flare nuts on both field and factory furnished components. After completion of leak testing, release test pressure and pull a vacuum on the system.



NOTE: Tightening of fittings and valves is the responsibility of the installing contractor

2.8 Evacuation

Evacuate the refrigerant lines, condenser coil and evaporator coil to 250 microns or lower (a micron gauge and 2-stage vacuum pump are required). Valve off and turn off the vacuum pump and wait for at least fifteen minutes to make sure the micron gauge reading does not go back up above 700 microns. If it does, re-start the vacuum pump and evacuate until the system reaches 250 microns. If the system still does not hold the pressure below 700 microns the system needs to be rechecked for leaks.

After the system has been satisfactorily evacuated the unit can be charged with refrigerant. Connect the pressure gauge manifold set to the high and low ports near the compressor, connect the charging line to the refrigerant tank and set it for liquid feed. Open the refrigerant tank valve and purge the line at the manifold, then open the high side valve on the manifold only, and allow the refrigerant to flow until the system pressure equalizes. At this point the system will have 75 to 80% of the total refrigerant charge. Start the blower and then the compressor checking the operating pressure and temperatures.



WARNING: DO NOT APPLY POWER TO THE COMPRESSOR WHEN IN A VACUUM

3.0 ELECTRICAL CONNECTIONS



WARNING: Before proceeding with electrical connections, make certain that the volts, hertz and phase correspond to that specified on the unit electrical nameplate. Use copper conductors only

3.1 Electrical Service

Check to be sure the service provided by the utility is sufficient to handle the additional load imposed by this equipment. Units with secondary heat exchangers will require a separate power source and field provided interconnecting control wires as well. Indoor split units typically have a single power source but can also be provided with separate sources. Field provided interconnecting control wires are also required. See Section 3.5 Auxiliary Control Wiring.

Remote outdoor condensers and condensing units require one power source. Glycol system with fluid coolers and loose pump(s) typically require one power source for the fluid cooler and will require one additional source for a single pump or two additional sources for dual pumps. Systems where the pumps are mounted and piped integral to the fluid cooler will usually require a single power source.

3.2 Nameplate Ratings

Refer to the unit nameplate for equipment electrical requirements. Minimum Circuit Ampacity (MCA), also known as wire sizing amps, will dictate the minimum required wire gauge. Maximum Overcurrent Protection (MOP) Device amps will dictate circuit breaker or fuse size.

3.3 Grounding

The unit cabinet must have an uninterrupted true earth ground. An electrical ground wire of adequate size must be connected to the ground lug provided inside the main electrical box.

3.4 Voltage Tolerance

The supply voltage to the unit must be within tolerance: - 5% to + 10% for 208-230 voltage. +10% for 460 volts. Phase to phase imbalance must not exceed 3%. The local utility company should be contacted for correction if improper line voltage exists. Deviation from ratings can cause premature failures and possibly void unit warranty.

3.5 Auxiliary Control Wiring

The interconnection of auxiliary control wiring for remote heat exchangers (condensers and fluid coolers) requires the connection of two (2) - 18-gauge wires for installations up to 150 feet (45 m) or 16-gauge wires for installations from 151 feet (46 m) up to 200 feet (61 m) from the electrical control box of the indoor evaporator to the electrical control box of the remote heat exchanger. Condensing units (i.e., where the compressor(s) are mounted in the remote heat exchanger) will

typically require (4) or more wiring connection points and may require heavier gauge wire. In this case, the installing contractor must follow the applicable electrical codes to determine the required wire gauge.

Because of the wide variety of indoor evaporators and remote heat exchangers offer by Data Aire, the installing contractor must refer to the schematic which is provided inside the electrical control box of each unit, for the required auxiliary control wiring interconnection terminal points.

Examples:

Figure 1 - Typical Remote Heat Exchanger Interconnection Points

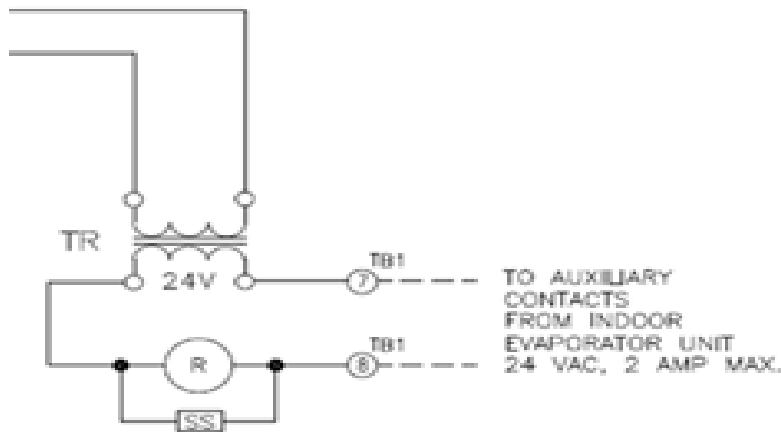
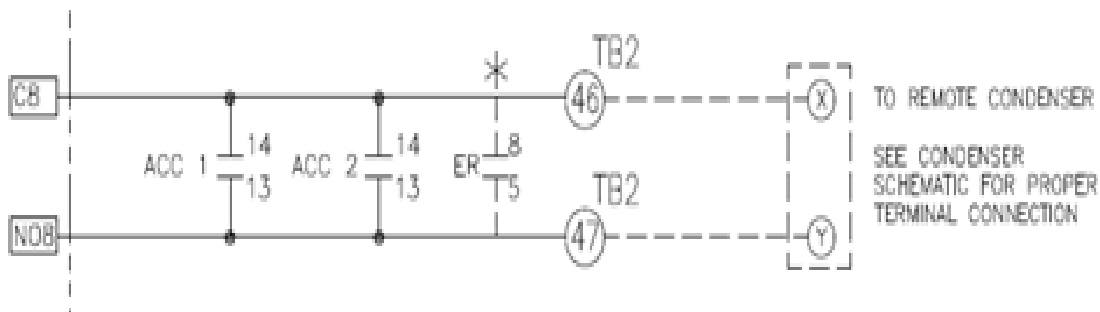

Figure 2 - Typical Indoor Evaporator Interconnection Points



3.6 Remote Shutdown

Every Data Aire evaporator has remote contact points available. These are intended for a field supplied dry contact or switch to be wired across two terminals. When the contact or switch opens, the control circuit power is interrupted and the unit shuts down, including the control panel. The control circuit is 24 VAC and the field provided contact or switch and wiring should have a minimum rating of 10 amps. A minimum of 18 gauge wire is recommended.

The remote shutdown contacts are always terminals #1 and #2 on the terminal block designated TB1. The unit is shipped with a factory jumper bar that connects terminal #1 to terminal #2. Remove this bar prior to installing the field wires.

3.7 Remote Alarm Contacts

3.7.1 Mini dap®4 Microprocessor Controller

Units with Mini dap4 microprocessor control panel, a remote output contact can be field accessed on terminals #14 and #15 of terminal block TB1. This is a normally Open (Close on Alarm) dry contact intended to be used in a control circuit not exceeding 2 amps at 250 VAC. This output contact will close on a failure and remain closed until the alarm is no longer present.

3.8 Remote Sensors

3.8.1 Mini dap4 Microprocessor Controller

The standard Mini dap4 microprocessor control panel normally comes with a remote mounted sensors for convenient means of field installation. When ordered, the remote sensors are shipped with 35 feet of cable and comes mounted in a plastic enclosure. The temperature and humidity sensors require a total of four wires. These wires should be twisted pair, shielded type (minimum of 22 gauge).

3.9 Condensate Pumps

The optional condensate pump that's shipped loose normally require a separate power source (110 volt). Always check the pump power requirements before connecting power. Condensate pumps are available in other voltages.

Optional condensate pumps that are factory wired and mounted do not require any additional wiring or a separate power source. However, field piping is still required.

4.0 INSTALLATION OF REMOTE OUTDOOR HEAT EXCHANGER

Air cooled condenser and fluid coolers have individual Installation, Operation and Maintenance manuals which should be referred to for more complete details

4.1 Rigging

The following covers outdoor condensers, condensing units and fluid coolers. Outdoor heat exchangers should be moved to their mounting location using a crane or fork lift as applicable. Each fan section has supports with lifting holes at the top.

Do not lift with a choke sling around the unit. Spreader bars are recommended for lifting multiple fan units. Under no circumstances should the coil headers or piping be used for lifting the unit. The unit should be kept in its shipping crate until it is ready to be set in place.

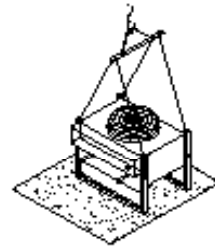
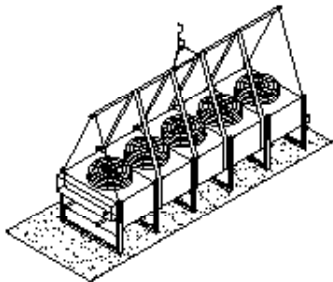

4.2 Leg Assembly

The legs of the remote heat exchanger are shipped with the unit in the “collapsed” position and need to be lowered during the rigging process. The legs must be unbolted from their collapsed position and extended prior to placing the units on its pad. Each leg extends down 18 inches and should be reattached using the same bolts. The bolts are placed through the lower set of holes on the bracket. Multiple fan units have leg supports between each section.

Concrete pads or a rail system are often used to provide support for the heat exchanger. Bolt holes in the bottom of each leg can be used to anchor the unit.

DARC-03 and DARC-05 units do not have legs and are ready for installation.



WARNING: Failure to extend the legs will result in poor air distribution over the cooling coil resulting in significant capacity reduction and potential high discharge pressure problems.

4.3 Locating the Remote Heat Exchanger

The remote heat exchanger must be located in an area that will ensure free air flow into and out of the heat exchanger plus adequate service access clearance. Short circuiting of the air flow or the intake of warmer air from another unit will seriously degrade the performance of the air cooled heat exchanger.

Do not locate the heat exchanger in a location that is bordered by tall obstructions (i.e. higher than 10 feet) on no more than two sides. See figure at right for minimum clearance from obstructions and between units. With proper clearance on all sides, two units can be placed side by side. Additional units should be placed at least 48 inches apart.

Noise factors should also be considered when locating an air cooled heat exchanger. Proximity to windows, walls and surrounding structures can cause objections by the occupants. An acoustical expert should be consulted when noise is of a particular concern.

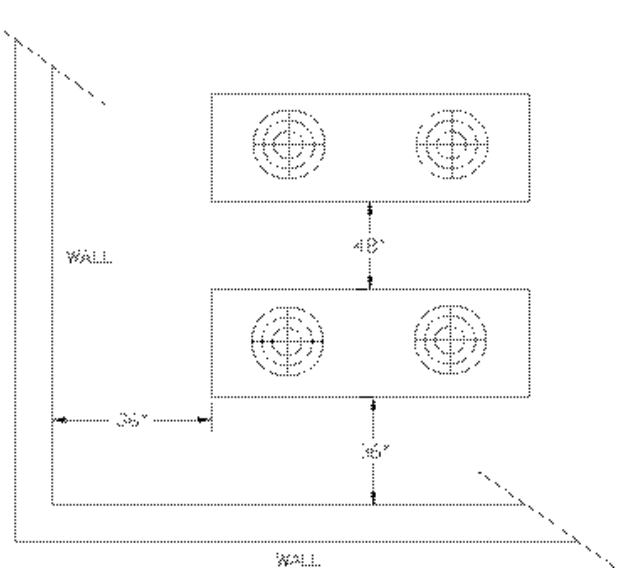

Air cooled heat exchangers should be placed at a level that is higher than the indoor evaporator. Installation of the remote heat exchanger (condenser or condensing unit) more than 10 feet below the evaporator is not recommended. Excessive liquid line pressure drop can cause poor evaporator performance.

Piping must be supported within 18 inches of the inlet and outlet connections. The inlet connection is located on the top header on all remote heat exchangers and the outlet connection is located on the bottom header of all units.

4.4. Electrical Service

Refer to Sections 3.1 to 3.5 for information regarding line voltage and control voltage wiring details.

4.5 Air Cooled Condensers – Model DARC

4.5.1 Fan Speed Control

Standard outdoor air cooled condensers have a fan speed controller on the first fan. On single fan condensers this is the only means of control. A variable speed controller modulates the motor speed based on system head pressure. The fan speed controller does not require field adjustment or programming.

4.5.2 Ambient Thermostats

Additional motors (subsequent to the fan speed control operated motor) on multiple fan heat exchangers are cycled by ambient sensing thermostats. These thermostats have a capillary tube with remote sensing bulb. They function best with the sensing bulb mounted below the coil, away from exposure to direct sun light and the bulb in the vertical position. An instruction set comes as part of a mounting kit that includes a sheet metal bracket, mounting clamps and TEK screws. This includes directions for field mounting and adjustment. Desired head pressure should be maintained at approximately 230-270 PSIG for R-407C and 340-400 PSIG for R-410A.

Typical factory settings:

Number of Fans	Motor No.1	Motor No. 2	Motor No. 3	Motor No. 4	Motor No. 5
1	FSC	N/A	N/A	N/A	N/A
2	FSC	Pressure Control	N/A	N/A	N/A
3	FSC	Pressure Control	75°F	N/A	N/A
4	FSC	Pressure Control	85°F	75°F	N/A
5	FSC	Pressure Control	85°F	75°F	65°F

4.6 Fluid Coolers – Model DAFC

4.6.1 Fluid-Sensing Thermostats

Fluid cooler fan motors are cycled on and off by individual water-sensing thermostats strapped to the leaving water header. The first fan motor will only have a thermostat if the unit has an Energy Saver coil. Without the optional Energy Saver coil the first fan motor runs whenever there is a call for cooling via an auxiliary signal sent by the indoor evaporator. See Section 3.5 – Auxiliary Control Wiring.

The water-sensing thermostats have adjustable setpoints which are typically staggered to maintain water temperature in a range of 85 to 105°F. This is generally the desired range for glycol cooled systems.

A surge tank is standard with all DAFC fluid coolers. This is sufficient for most applications. However, an expansion tank is recommended and should be installed at the highest point in the system and the point of least pressure.

4.6.2 Energy Saver Cooling

In colder ambient climates units may be equipped with an additional free cooling coil. When incoming fluid temperature falls below the setpoint of a water-sensing thermostat in the evaporator (typically 50°F), Energy Saver or free cooling becomes available.

Systems with an Energy Saver coil should have at least one fluid-sensing thermostat on the fluid cooler set lower to take advantage of the colder ambient temperatures. The desired fluid temperature for Energy Saver cooling is 45°F. Field adjustment of fluid sensing thermostats is not unusual.

It is desirable to use the Energy Saver mode as much as possible to maximize the free cooling feature. However, fluid temperature that is too cold can cause excessive dehumidification and coil sweating. Fluid temperature that is too high can cause the indoor space temperature to rise. This could cause the evaporator’s microprocessor control to lock out the Energy Saver mode for one a fixed period of time while it reverts back to compressor (mechanical) cooling. Adjust setpoints of the thermostats to allow the maximum free cooling time. Over cooling or under cooling the fluid should be avoided.

	<p>WARNING: Every application will have a different ambient temperature and indoor heat load/air distribution profile. It is not possible to dictate the exact water-sensing thermostat setpoints. Field adjustments are typical to allow fine tuning to specific conditions.</p>
---	--

5.0 CHARGING

5.1 Voltage Phase Check

5.1.1 Evaporator

Prior to charging, the correct voltage phasing should be checked on the indoor evaporator. Check blower direction on the evaporator by momentarily energizing the fan motor. Reverse any two of the three line voltage wires at the line voltage field connection point to change the blower rotation.

Although the scroll compressor is phase dependent, units shipped from the factory are run tested ensuring compressor rotation is consistent with the evaporator fan motor. However, a field change-out of the compressor may require checking proper phase. An out of phase compressor will draw relatively low amps and both suction and discharge pressures will remain nearly equal.

5.1.2 Secondary Heat Exchanger

The secondary heat exchanger may be ordered as three phase but the individual fan motors are single phase and will only run in one direction. Check operation by placing a momentary jumper across low voltage terminals #39 and #40 (disconnect pumps on glycol systems unless already filled with water/glycol solution). Placing a jumper across terminal #39 and #40 will energize the control circuit. Fans may not run because the thermostat is above the current ambient or the #1 fan on air cooled condensers with fan speed control has not reacted to the head pressure. The fan will not run until the head pressure is well over 200 PSIG.

5.2 Air Cooled Systems

5.2.1 Package Air Cooled Systems

Packaged air cooled units come factory charged because all of the refrigerant carrying components are self-contained with the evaporator and condenser sections.

A properly charged system operating at typical parameters will have the following pressures:

Units with R-407C	Head pressure	240 – 295 PSIG
	Suction Pressure	58 PSIG or greater
Units with R-410A	Head pressure	340 – 415 PSIG
	Suction pressure	104 – 121 PSIG

The superheat at the compressor suction line should be 8 – 15 degrees. Sub-cooling should be 8 – 10 degrees.

An air cooled package unit may require field charging if a compressor is changed, if a leak develops or if non-condensable are in the system. Field charging should be done by referring to the unit electrical nameplate for the factory charge.

Although this value represents the original factory charge, it is still necessary to measure and note proper unit operation including superheat, sub-cooling, head and suction pressure. Some adjustment to charge may be required.



WARNING: Before starting a compressor, the crankcase heater should be energized for a minimum of 12 hours to reduce the possibility of liquid slugging on start-up. Failure to energize the crankcase heater could result in compressor damage.

5.2.2 Split Indoor Air Cooled Systems Charging (Units with Indoor Condenser)

After refrigerant piping is properly completed, connect the refrigerant drum to the low side and charge with vapor. For systems with R-407C, charge with approximately 2.55 lbs. per nominal ton. Systems with R-410A require 3 lbs. per nominal ton.

For example, a model DAPA-0312 is a nominal 3 ton unit. Charge with about 7.65 lbs. of refrigerant if R-407C. 9 lbs. if R-410A. It is likely that more refrigerant will be required to complete the charging procedure for additional piping between the evaporator and the condenser. Make sure all hoses are properly purged. From a vacuum, feed liquid refrigerant into the high side of the system until the pressures equalizes. At this point there will be about 70-80% of the total charge in the system.



WARNING: Before starting a compressor, the crankcase heater should be energized for a minimum of 12 hours to reduce the possibility of liquid slugging on start-up. Failure to energize the crankcase heater could result in compressor damage. If the system is charged from a vacuum, the pre-heating of the compressor is not necessary.

Start the evaporator fan and compressor. Check the liquid line sight-glass to get a feel for the approximate charge. Bubbles in the sight-glass are not unusual at this point and can be caused by flashing from liquid line pressure drop, low sub-cooling or low charge. It is likely more refrigerant will be required to complete the charging procedure.

Adjust the refrigerant charge until the sub-cooling is 8 to 10° and has sparse bubbles. The unit should be allowed to stabilize for several minutes before meaningful measurements can be taken.

A properly charged system operating at typical parameters will have the following pressures:

Units with R-407C	Head pressure	240 – 295 PSIG
	Suction Pressure	58 PSIG or greater
Units with R-410A	Head pressure	340 – 415 PSIG
	Suction pressure	104 – 121 PSIG

The superheat at the compressor suction line should be 8 – 15 degrees. Sub-cooling should be 8 – 10 degrees.



NOTE: Charging to a full liquid line sight-glass should never be the sole means of determining the correct refrigerant charge. Other parameters such as superheat, suction pressure, head pressure, sub-cooling and ambient temperature are also important. A system charged to a clear sight-glass is often overcharged.

5.2.3 Fan Speed Control System Charging (Units with Remote Outdoor Condenser)

The standard outdoor air cooled condenser provided by Data Aire has fan speed control. The fan speed controller does not require field adjustment or programming.

After refrigerant piping is properly completed, connect the refrigerant drum to the low side and charge with vapor. For systems with R-407C, charge with approximately 2.55 lbs. per nominal ton. Systems with R-410A require 3 lbs. per nominal ton.

For example, a model DAPA-0312 is a nominal 3 ton unit. Charge with about 7.65 lbs. of refrigerant if R-407C. 9 lbs. if R-410A. It is likely that more refrigerant will be required to complete the charging procedure for additional piping between the evaporator and the condenser. Make sure all hoses are properly purged. From a vacuum, feed liquid refrigerant into the high side of the system until the pressures equalizes. At this point there will be about 70-80% of the total charge in the system.



WARNING: Before starting a compressor, the crankcase heater should be energized for a minimum of 12 hours to reduce the possibility of liquid slugging on start-up. Failure to energize the crankcase heater could result in compressor damage. If the system is charged from a vacuum, the pre-heating of the compressor is not necessary.

Start the evaporator fan and compressor. Check the liquid line sight-glass to get a feel for the approximate charge. Bubbles in the sight-glass are not unusual at this point and can be caused by flashing from liquid line pressure drop, low sub-cooling or low charge. It is likely more refrigerant will be required to complete the charging procedure.

Adjust the refrigerant charge until to a sub-cooling of 8 to 10° and has sparse bubbles. The unit should be allowed to stabilize for several minutes before meaningful measurements can be taken.

A properly charged system operating at typical parameters will have the following pressures:

Units with R-407C	Head pressure	240 – 295 PSIG
	Suction Pressure	58 PSIG or greater
Units with R-410A	Head pressure	340 – 415 PSIG
	Suction pressure	104 – 121 PSIG

The superheat at the compressor suction line should be 8 – 15 degrees. Sub-cooling should be 8 – 10 degrees.



NOTE: Charging to a full liquid line sight-glass should never be the sole means of determining the correct refrigerant charge. Other parameters such as superheat, suction pressure, head pressure, sub-cooling and ambient temperature are also important. A system charged to a clear sight-glass is often overcharged.

5.2.4 Flooded System Charging

Flooded systems include an optional liquid receiver and head pressure control valve for use primarily in colder climates. When the ambient temperature falls during cold weather, the head pressure control valve will regulate the flow of refrigerant to ensure nearly constant receiver pressure. The receiver is partially flooded with liquid refrigerant in cold weather. In warm weather the extra refrigerant is stored in the receiver.

Flooded systems require more refrigerant than units with fan speed control. Connect the pressure gauge manifold set to the high and low ports near the compressor. Connect the charging line to the refrigerant tank and set it for liquid feed. Open the refrigerant tank valve and purge the line at the manifold. Open the high side valve on the manifold only and allow the refrigerant to flow until the system pressure equalizes. At this point the system will have 75 to 85% of the total refrigerant charge. Start the evaporator blower. Start the compressor and check the operating pressures and temperatures.



WARNING: Before starting a compressor, the crankcase heater should be energized for a minimum of 12 hours to reduce the possibility of liquid slugging on start-up. Failure to energize the crankcase heater could result in compressor damage. If the system is charged from a vacuum, the pre-heating of the compressor is not necessary.

Start the evaporator fan and verify the fan rotation. Start the compressor. Check the liquid line sight-glass to get a feel for the approximate charge. Bubbles in the sight-glass are not unusual at this point and can be caused by flashing from liquid pressure drop, low sub-cooling or low charge. It is likely more refrigerant will be required to complete the charging procedure.

If the receiver (head) pressure is below 230 PSIG, block part of the condenser coil surface until the pressures rises to 230 PSIG or greater. During extremely cold weather all the condenser fans may have to be de-energized to maintain 230 PSIG.

Observe the sight-glass on the receiver. Add refrigerant through the suction line until the level of liquid in the receiver is approximately 1/3 from the bottom of the sight-glass (the leveling ball in the receiver will start to float). At this point the charging is correct. Observing the receiver sight-glass becomes difficult when they are remotely mounted near the condenser. The unit should be allowed to stabilize for several minutes before meaningful measurements can be taken.

After the system is allowed to stabilize, the superheat at the compressor suction line (reading from at least 6 inches from the compressor) should be 8 to 15°F. Units with remote condensing units (DRCU), the superheat should be 20 to 25°F at the compressor. Remove any block that may have been used on the condenser coil. If the ambient temperature while charging is below 70°F, some of the refrigerant will be backed up into the condenser coil causing the liquid level in the receiver to drop (this is normal).



NOTE: Charging to a full liquid line sight-glass should never be the sole means of determining the correct refrigerant charge. Other parameters such as superheat, suction pressure, head pressure, sub-cooling and ambient temperature are also important. A system charged to a clear sight-glass is often overcharged.

5.3 Water/Glycol Cooled Systems

5.3.1 Water/Glycol Cooled System Charging

All water/glycol cooled units are factory charged with refrigerant. The water regulating valve should be adjusted to maintain a condensing temperature of 105 to 119°F. Saturated suction temperature should be 33°F or higher. The superheat at the compressor suction line (measured at least 6 inches away from the compressor) should be 8 to 15°F.

Field charging water/glycol systems (if required) should be done by referring to the unit's electrical nameplate. The factory charge is indicated on the nameplate. Although this value represents the original factory charge, it is still necessary to measure and note proper unit operation including superheat, head and suction pressure. Some adjustment to the refrigerant may be required.

Adjust the refrigerant charge until the sight-glass clears or has sparse bubbles. The unit should be allowed to stabilize for several minutes before meaningful measurements can be taken and the conditioned space should be at or near the temperature setpoint.

All water/glycol cooled units have a water regulating valve. A head pressure sensing transducer is connected to a schrader fitting on the discharge line and water is regulated into the condenser coil. Standard condensers are plate fin type.



WARNING: Before starting a compressor, the crankcase heater should be energized for a minimum of 12 hours to reduce the possibility of liquid slugging on start-up. Failure to energize the crankcase heater could result in compressor damage. If the system is charged from a vacuum, the pre-heating of the compressor is not necessary.



NOTE: Charging to a full liquid line sight-glass should never be the sole means of determining the correct refrigerant charge. Other parameters such as superheat, suction pressure, head pressure, sub-cooling and ambient temperature are also important. A system charged to a clear sight-glass is often overcharged.

5.3.2 Factory Charge for Water/Glycol Cooled Systems

Evaporator Model	R-407C	R-410A
DAPW/G 2.5	Consult Factory	Consult Factory
DAPW/G 03	Consult Factory	Consult Factory
DAPW/G 04	Consult Factory	Consult Factory
DAPW/G 05	Consult Factory	Consult Factory

5.4 Refrigerant Handling

The use of recovery/recycling is required by the US Environmental Protection Agency (EPA) regulations. Technicians who service and dispose of air conditioning and refrigeration equipment must recover the refrigerant instead of venting to the atmosphere.

Except for extremely small releases of refrigerant such as those that occur when disconnecting service hoses (diminutive release), a technician who knowingly releases or vents refrigerant to the atmosphere is in violation of these regulations. Freon purchasers must be certified technicians and have a valid EPA certification card.

Warning! Pressure relief lines(s) must be vented to the atmosphere per the latest edition of ASHRAE Standard 15 and/or any local building, fire or mechanical codes.

This applies to all units with either sell and tube condensers or high pressure relief valve options.

5.5 Important Refrigeration Components

5.5.1 Expansion Valve

Each refrigerant circuit has an adjustable thermo-expansion valve (TXV). They are factory adjusted to their nominal rating. Any field adjustment should be to “fine tune” a system that has been stabilized and already has acceptable operating parameters.

5.5.2 High Pressure Cutout Switch

Each refrigeration circuit is protected by a high head pressure cutout switch with a manual reset button. The switch is located near the compressor.

The pressure rating for R-407C systems is 400 PSIG.

The pressure rating for R-410A systems is 610 PSIG.

5.5.3 Low Pressure Cutout Switch

Each circuit includes a low pressure cutout switch with automatic reset. The switch is located near the compressor section.

The pressure rating for R-407C systems is 28 PSIG.

The pressure rating for R-410A systems is 50 PSIG.

6.0 GLYCOL SYSTEMS

6.1 Glycol Concentration

The system must be filled with water and the appropriate amount of ethylene or propylene glycol to protect against winter freezing. To achieve the approximate glycol concentration, it is necessary to know the total system volume. The total system volume consists of the fluid cooler volume, the evaporator unit volume and the volume of the inter-connecting piping.

The following tables can be used for arriving at an approximate system volume. After installation, the glycol percentage should be checked. The glycol percentage should be checked at regular intervals to ensure against freeze protection.

6.2 Internal (Fluid) Volume

Evaporator Model	Volume (gallons) - no Energy Saver Coil	Volume (gallons) – with Energy Saver Coil
DAPG 2.5	1.0	2.5
DAPG 03	1.0	2.5
DAPG 04	2.5	4.0
DAPG 05	2.5	4.0

6.3 Fluid Cooler Internal Volume

Fluid Cooler	Volume (gallons)	Fluid Cooler	Volume (gallons)
DAFC 06	2.5	DAFC 17	6.6
DAFC 07	3.4	DAFC 21	7.4
DAFC 09	4.2	DAFC 24	9.8
DAFC 11	3.3	DAFC 29	12.3
DAFC 15	4.9		

6.4 Copper Piping Internal Volume

Pipe Diameter Inches O.D.	Volume per 100 feet of Pipe (gallons)
5/8	1.2
3/4	1.8
7/8	2.5
1-1/8	2.5
1-5/8	4.3
2-1/8	9.2

6.5 Freezing Point of Aqueous Solutions

Ethylene Glycol Percent by Volume	Freezing Point °F	Propylene Glycol Percent by Volume	Freezing Point °F
0	32	0	32
10	24	10	27
20	15	20	18
30	4	30	8
40	-13	40	-6
50	-33	50	-26

7.0 CONTROLS

7.1 Mini dap4 Microprocessor Control Panel

The Mini dap4 microprocessor control panel is standard on all Mini-Plus units. There is a separate manual with extensive detail regarding the functions, features, programming and troubleshooting.



WARNING: The Mini dap4 microprocessor control panel has an entire manual dedicated to its use and operation. The manual must be referenced to complete a thorough unit installation. Start-up is not complete until the Mini dap4 control panel settings are established.

7.2 Optional Expanded dap4

The Expanded dap4 is available as an option and offers additional features and additional analog inputs/outputs. There is a separate manual with extensive detail regarding the functions, features, programming and troubleshooting.



WARNING: The dap4 microprocessor control panel has an entire manual dedicated to its use and operation. The manual must be referenced to complete a thorough unit installation. Start-up is not complete until the dap4 control panel settings are established.

7.3 Optional Thermostat

For installations not requiring close environmental control, a single stage cooling thermostat is available. Units with either humidifiers and/or electric reheat require Mini dap4 or Expanded dap4.

7.4 Optional Programmable Thermostat

Thermostat allows simple programmable functions. Units with either humidifiers and/or electric reheat require the Mini dap4, the Expanded dap4.

7.5 Wiring Diagrams

Every Data Aire evaporator, condenser, condensing unit or fluid cooler comes with a wiring diagram. These diagrams are ladder type schematics intended for service personnel. The intent is to allow the technician to understand the wiring details associated with the electrical components and how they interface with the controls as well as peripheral equipment (including secondary heat exchangers).

The wiring diagram in the evaporator will indicate field interface terminals to the secondary heat exchanger. The internal wiring of the heat exchanger is found on a separate diagram which can be found on the inside cover of the heat exchanger electrical box. Both diagram types are also placed inside the shipping/warranty packet secured in the evaporator section.

Evaporator wiring diagrams will have a drawing number that starts with a three letter designation, "DAM". An example of a typical diagram is DAM-S-908. Wiring diagrams for condensers or condensing units start with the three letter designation, "DRC". A typical diagram example would be DRC-S-001. Fluid coolers begin with the three letter designation "DFC". A typical fluid cooler diagram would be DFC-S-001.

8.0 REGULAR MAINTENANCE ITEMS

8.1 Air Filters

Air filters should be checked on a regular basis and changed when they become dirty. This will ensure efficient operation of the unit. Spare air filters should be kept in stock as these tend to be a frequently replaced maintenance item. Air filters may require changing as often as monthly dependent on room or space conditions. New installations with construction dust will quickly clog filters requiring new filters.

The Mini dap4 or optional Expanded dap4 control panels can monitor air filter status with an optional dirty filter sensor. A dirty filter alarm will be enunciated on the controls display screen. Although the unit may display a dirty filter alarm, this should not be relied on as the only determinant for replacing air filters. A misadjusted air filter differential pressure switch may not give a proper indication of a clogged filter.

To check the air filter pressure differential pressure switch for proper adjustment, temporarily cover approximately 75% of the return air opening using heavy cardboard or similar material. The alarm should energize when 75% of the air is blocked, simulating dirty filters. If the alarm energizes prematurely or does not energize at all, the pressure switch should be adjusted. Panels must remain closed when determining if an adjustment is necessary.



WARNING: Air filters that require changing can restrict airflow and create problems such as coil icing or poor air distribution.

8.2 Belts

Belt tension should be checked on a regular basis (monthly) to ensure proper tension. If tightening is required, loosen the four mounting bolts. Turn the adjustment screw on the end of the motor mounting channel until the proper belt tension is attained. Retighten the four mounting bolts. Damage can occur from belts that over tightened. The amount of play in a typical drive set should be 1/2 inch. When tightening the belts make sure the pulley alignment is true. If the belts are over tightened or if the pulleys are misaligned, the bearing life and belt life are shortened considerably.

8.3 Bearings

Blower bearings used with Mini-Plus ceiling units are permanently lubricated and do not require maintenance.

Some motors have Zirk type grease fittings on the bearings. If so, the motor should be greased at least annually. Use NLG1 grade 2 lithium or lithium complex grease. Care should be taken to avoid over-greasing the bearings. Only one or two pumps from a manual gun are required.

8.4 Humidifier Canisters

The optional steam generator type humidifier does not require maintenance other than to replace the canister as required. The frequency of change will depend on usage and water type. A set of the humidifier manufacturer's instructions is included with the paperwork placed inside the unit when it ships.

8.5 Fuses

Fuses may occasionally require changing especially with installations where the voltage is not consistent. Drops in voltage can create brief periods of high amp draw, causing fuses to blow. Always replace fuses with those of the equivalent rating with regard to: 1) amperage, 2) voltage and 3) speed. For instance – compressors are and motors are inductive loads which require time delay fuses where electric reheat and humidifiers are resistive loads requiring fast acting fuses.

8.6 Heating Elements

Heating elements do not normally require maintenance. However, they may accumulate a film of dust or dirt when unused for extended periods of time. When energized, the burning debris can create smoke or an unpleasant odor. To help avoid a problem, periodic cleaning is recommended.

8.7 Refrigerant Filter Drier

Factory installed refrigerant filter driers do not require maintenance or replacement unless the system has been opened. When replacing compressors or other repairs that open the refrigeration system to the atmosphere, it is always advisable to replace the filter drier. The equivalent type and size should be used.

9.0 WARRANTY POLICY

Seller warrants its equipment to Buyer to be free from defects in material and workmanship for a period of eighteen (18) months from date of shipment, as long as equipment is utilized under normal conditions and service and is properly installed; however, the warranty shall not be applicable to any of the following items: refrigerant, belts, filters, humidifier, heaters not regularly cleaned, light bulbs, and any other items either consumed or worn out by normal wear and tear, or by conditions beyond Seller's control, including (without limitation as to generally) polluted or contaminated air or water.

The Seller's obligation under this warranty is limited solely to the repair or replacement, at Seller's options, of any part or parts thereof which shall, within eighteen (18) months from date of shipment of the equipment to the original purchaser be returned to the factory, transportation charges repaid, which upon examination shall disclose to the Seller's satisfaction to have been defective under normal use and service. This agreement to repair or replace defective parts is expressly in lieu of all other warranties, expressed or implied and all other obligations or liabilities on the part of the Seller and Seller neither assumes nor authorizes any other person to assume for it any liability or obligation in connection with the sales or service of its equipment, except said repair or replacement of defective parts set forth above.

This warranty does not include any labor charges for work done outside the factory for replacement of parts, adjustments, repairs, or any other work. Seller's liability does not include any resulting damage to persons, property, equipment, goods or merchandise arising out of any defect in or failure of any equipment of its manufacture and Buyer hereby waives any claim against Seller arising out of such claim. This warranty shall not cover the repair or replacement of any equipment which has been repaired or altered outside the factory in any way or which has been subject to negligence, misuse, or abuse, or to pressures in excess of stated limits.

This warranty applies only to the original purchaser of the equipment and does not extend, expressly or by implication, to the third parties or others without specific written approval and acknowledgment of Seller. Buyer's exclusive remedy and Seller's maximum liability for any and all loss, injury, damage, costs, or expense arising from any defect covered by this warranty shall be limited to the repair or replacement, but not the installation of any defective material, F.O.B., Seller's plant; provided however, that Seller shall not be required to replace any part or component (a) which can be repaired, or (b) unless Buyer has given Seller immediate written notice that replacement or repair. In addition, Seller shall not be liable for any cost or expense of replacement or repair contracted for by Buyer with any third person, unless, and then only to the extent that Seller authorizes in writing, such costs or expense.

Seller shall not be liable for any direct, indirect incidental, consequential, or other form of loss, injury, damage, cost, or expense, whether caused by delay, failure, or performance, breach of warranty, or by any cause whatsoever.

Seller's obligation under this warranty shall be void if Buyer fails: (a) without legal justification to pay Seller, when due, the full purchase price for the equipment sold hereunder, or (b) to have the equipment sold hereunder installed, maintained, and serviced by competent personnel and in accordance with Seller's instructions.

10.0 CONTACT DATA AIRE

Address:

Data Aire, Inc.
230 West BlueRidge Avenue
Orange, CA 92865

Telephone:

714-921-6000
800-347-AIRE (2473) Toll Free

E-mail:

Service@dataaire.com
Engineering@dataaire.com
Sales@dataaire.com

Fax:

714-921-6010 Main
714-921-6011 Engineering
714-921-6022 Parts Sales

Web Site: www.dataaire.com

Job/Unit Information:

Data Aire Job Number: _____

Evaporator Serial Number: _____

Evaporator Model Number: _____

Condenser/Fluid Cooler Serial Number: _____

Condenser/Fluid Cooler Model Number: _____

RECOMMENDED LINE SIZING for AIR COOLED SPLIT SYSTEMS

HOT GAS LINES – SINGLE CIRCUIT UNITS (Up To 200 Equivalent Feet)

Tonnage	Tons/Circuit	50 feet	100 feet	150 feet	200 feet
2.5	2.5	5/8	7/8	7/8	7/8
3	3	7/8	7/8	7/8	7/8
4	4	7/8	7/8	7/8	1-1/8
5	5	7/8	1-1/8	1-1/8	1-1/8

LIQUID LINES – SINGLE CIRCUIT UNITS (Up to 200 Equivalent Feet)

Tonnage	Tons/Circuit	50 feet	100 feet	150 feet	200 feet
2.5	2.5	3/8	1/2	1/2	1/2
3	3	1/2	1/2	1/2	1/2
4	4	1/2	5/8	5/8	5/8
5	5	1/2	5/8	5/8	5/8

SUCTION LINES – SINGLE CIRCUIT UNITS (Up to 200 Equivalent Feet)

Tonnage	Tons per Circuit	50 feet		100 feet		150 feet		200 feet	
		HOR	VER	HOR	VER	HOR	VER	HOR	VER
2.5	2.5	7/8	7/8	7/8	7/8	7/8	7/8	1-1/8	7/8
3	3	7/8	7/8	1-1/8	7/8	1-1/8	7/8	1-1/8	7/8
4	4	1-1/8	1-1/8	1-1/8	1-1/8	1-1/8	1-1/8	1-3/8	1-1/8
5	5	1-1/8	1-1/8	1-1/8	1-1/8	1-3/8	1-1/8	1-3/8	1-1/8

HOR = HORIZONTAL

VER = VERTICAL

TEMPERATURE-PRESSURE CHART

R-407C

R-410A

TEMPERATURE (°F)	PRESSURE (PSIG)	PRESSURE (PSIG)
26	43.6	89.7
27	44.7	91.6
28	45.9	93.5
29	47.1	95.5
30	48.4	97.5
31	49.6	99.5
32	50.9	101.6
33	52.1	103.6
34	53.4	105.7
35	54.8	107.9
36	56.2	110.0
37	57.5	112.2
38	58.9	114.4
39	60.3	116.7
40	61.7	118.9
41	63.1	121.2
42	64.6	123.6
43	66.1	125.9
44	67.6	128.3
45	69.1	130.7
46	70.6	133.2
47	72.2	135.6
48	73.8	138.2
49	75.4	140.7
50	77.1	143.3
55	106.0	156.6
60	116.2	170.7
65	127.0	185.7
70	138.5	201.5
75	150.6	218.2
80	163.5	235.9
85	177.0	254.6
90	191.3	274.3
95	206.4	295.0
100	222.3	316.9
105	239.0	339.9
110	256.5	364.1
115	274.9	389.6
120	294.2	416.4
125	314.5	444.5
130	335.7	474.0
135	357.8	505.0
140	380.9	537.6
145	405.1	571.7
150	430.3	607.6

Superheat and Suction Pressure Troubleshooting Guide

Low Suction Pressure and High Superheat

1. Moisture, wax, dirt in system
2. Undersized valve
3. High superheat adjustment
4. Gas charge condensation
5. Dead thermostatic element charge
6. Wrong thermostatic charge
7. Evaporator pressure drop – no external equalizer
8. External equalizer location
9. Restricted or capped external equalizer
10. Low refrigerant charge
11. Liquid line vapor
 - a. Vertical lift
 - b. High friction loss
 - c. Long or small line
 - d. Plugged drier or strainer
12. Low pressure across valve
 - a. Vertical lift
 - b. Undersized distributor nozzle or circuits
 - c. Low condensing temperature

High Suction Pressure and Low Superheat

1. Oversized valve
2. TEV seat leak
3. Low superheat adjustment
4. Bulb installation
 - a. Poor thermal contact
 - b. Warm location
5. Wrong thermostatic charge
6. Bad compressor – low capacity
7. Moisture, wax, dirt in system
8. Incorrectly located external equalizer

Low Suction Pressure and Low Superheat

1. Low load
 - a. Insufficient air flow
 - b. Dirty air filters
 - c. Coil icing
2. Poor air distribution
3. Poor refrigerant distribution
4. Improper compressor/evaporator balance
5. Evaporator oil logged

QUARTERLY MAINTENANCE/INSPECTION CHECKLIST

Evaporator Model No. _____ Evaporator Serial No. _____

Technician: _____ Date: _____

Electrical Section

- ___ Inspect fuses
- ___ Inspect wire connections
- ___ Inspect contactors

Controls

- ___ Circle control type: Mini dap4 Expanded dap4
- ___ Check unit control operation
- Check operation of the following:
 - ___ High water alarm
 - ___ Pressure differential switch (optional)
 - ___ Air flow switch

Air Filters

- ___ Inspect and replace (if required)
- ___ Inspect grille area and ensure unrestricted

Blower Section

- ___ Check blower wheel movement to be free and clear of any debris
- ___ Check belt tension and condition (replace if required)
- ___ Check bearings
- ___ Check sheave/pulley alignment
- ___ Check motor mount/alignment
- ___ Record motor amp (draw) L1 _____ L2 _____ L3 _____

Humidifier (steam generator)

- ___ Inspect drain valve/trap/drain line
- ___ Check for leaks (make-up water/hoses)
- ___ Check humidifier canister (replace if needed)
- ___ Check and clean fill strainer
- ___ Check operation
- ___ Record humidifier amp draw L1 _____ L2 _____ L3 _____

Reheat

- ___ Inspect element (and clean if required)
- ___ Check wiring
- ___ Record amps _____

Refrigeration Piping

- ___ Check for lines (leaks/lines secure)
- ___ Check capillary lines

Condensers (Water-Cooled)

- Check for leaks
- Entering/leaving water temperatures ENT ____° LVG ____°

Compressor

- Check for oil leaks
- Check compressor mounting
- Inspect wire connection
- Record suction pressure ____ PSIG
- Record discharge pressure ____ PSIG
- Record superheat ____ °
- Record sub-cooling ____ °
- Check high pressure cut-out ____ PSIG
- Check low pressure cut-in ____ PSIG
- Check low pressure cut-out ____ PSIG
- Record compressor amp draw L1 ____ L2 ____ L3 ____

Condensate Pan

- Check for debris
- Inspect/check float operation
- Check pump operation

Air Cooled Condenser (if applicable)

- Inspect coil/clean if required
- Inspect motor/motor mounts
- Inspect fan blade(s)
- Check wiring
- Inspect piping for leaks

Dry Cooler (if applicable)

- Inspect coil/clean if required
- Inspect motor/motor mounts
- Inspect fan blade(s)
- Check wiring
- Inspect piping for leaks

Glycol Pump (if applicable)

- Glycol leaks
- Pump operation

Mini-Plus Ceiling Systems

Air, Water and Glycol Cooled DX and Chilled Water
Installation, Operation & Maintenance Manual



Data Aire, Inc. | 230 W. BlueRidge Avenue | Orange, CA 92865 | www.dataaire.com

ISO 9001-2008 Certified | ©Copyright 2017 Data Aire, Inc. | A member of the CS Group of Companies | Making Products That Make Building Better